

User manual
Ergo Stand
(KP-80)



GENERAL WARNING

IMPORTANT

WARNING:

- Use of this product requires a clinician's diagnosis of suitability with non-obstructed hip joint and stable lower extremities and good bone status.

Do not attempt to use the wheelchair before a qualified person has explained to your satisfaction how to operate it without risk to yourself or others.

Due to the change of design, some illustrations and pictures in this owner's manual may not correspond to the wheelchair that you purchased. KARMA reserves the right to make design modifications without further notice.

WARNING:

- Do not operate this wheelchair before first reading and understanding this owner's manual. If you are unable to understand the warnings, cautions and healthcare professional or technical instructions, contact a dealer, personnel if applicable before attempting to use this wheelchair—otherwise, injury or damage may occur. If any procedures other than those described in this owner's manual, it must be carry out by a qualified technician.

THE INFORMATION CONTAINED IN THIS DOCUMENT IS SUBJECT TO CHANGE WITHOUT NOTICE.

WARNING:

- As a manufacturer of power wheelchairs, KARMA endeavours to supply a wide variety of power wheelchairs to meet the many needs of the user. However, the responsibility of final selection of the type of power wheelchair to be used by an individual rests solely with the user and his/her health care professional capable of making such a selection. KARMA recommends that power wheelchair users NOT be transported in vehicles of any kind while in a power wheelchair. As of this date, the Department of Transportation (U.S.) has not approved any tie-down

systems for transportation of a user while on a power wheelchair in a moving vehicle of any type. It is the position of Karma that users of power wheelchairs should be transferred into appropriate seating in vehicles for transportation and make use of the restraints made available by the auto industry. Karma cannot and does not recommend any power wheelchair transportation systems. It is the responsibility of the Durable Medical Equipment (DME) Dealer, therapists and other healthcare professionals to determine if a seat positioning strap is required to ensure the safe operation of this equipment by the user. Serious injury can occur in the event of a fall from a power wheelchair.

OPERATION INFORMATION

Adjustments should ONLY be made by professionals of the healthcare field or persons fully conversant with this process and the driver's capabilities.

Incorrect settings could cause injury to the driver or bystanders and damage to the power wheelchair and surrounding property

To determine and establish your particular safety limits, practice bending, reaching, mounting and dismounting activities in several combinations in the presence of a qualified healthcare professional BEFORE attempting active use of the power wheelchair

- For individuals with balance problems, practice mounting and dismounting activities WITH AN ASSISTANT in the presence of a qualified healthcare professional.
- If so equipped, DO NOT operate the wheelchair without anti-tippers being installed. Anti-tippers MUST BE attached at all times.
- **DO NOT** attempt to reach objects if you have to move forward in the seat or pick them up from the floor by reaching down between your knees as this may cause loss of balance.
- **DO NOT** lean over the back of the chair to reach objects behind you as this may cause the power wheelchair to tip over.
- **DO NOT** shift your weight or sitting position toward the direction you are

reaching as the power wheelchair may tip over.

- **DO NOT** use an escalator to move a power wheelchair between floors. Serious bodily injury may occur.
- **DO NOT** operate in car lanes on roads, streets, highways, etc.
- **DO NOT** attempt to move up or down an incline with a water, ice or oil film.
- **DO NOT** attempt to ride over curbs or obstacles. Doing so may cause your power wheelchair to turn over and cause bodily harm and/or damage to the power wheelchair.
- **DO NOT** make sharp turns, in forward or reverse, at excessive speeds.
- **DO NOT** attempt to lift the power wheelchair by its casings and seat.
- **DO NOT** attempt to lift the power wheelchair by any detachable parts
Lifting by means of any detachable parts of a power wheelchair may result in injury to the user or damage to the power wheelchair. Please hold onto the frame when lifting your wheelchair.
- **DO NOT** operate the power wheelchair until you have checked that the surroundings are clear and that the area is safe for Travel.
- **DO NOT** use stand-up function on a slope.
- Please pay attention to the environment, and to keep away from the hazard of external flame. When the user is smoking, pay attention to safety and make sure to extinguish the fire when finished. Be alert to the environment when someone nearby is smoking or using a cigarette lighter, keep away from the hazard and use fire-proof cloth.
- **DO NOT** use parts, accessories or adapters other than those authorized by Karma. Before attempting to sit in or exit the power wheelchair, turn the power OFF. This will ensure that the power wheelchair will not drive. Turn the power OFF while the wheelchair is not in use. Otherwise, injury and/or damage to the wheelchair and surrounding property may occur.
- **DO NOT** connect any medical device (i.e., a ventilator, life support machine, et cetera) to the battery. This could cause unexpected failure of the device and the power wheelchair. KARMA specifically disclaims responsibility to all personal injury and property damage that may occur during use which does not comply with applicable federal, state and local laws and ordinances.

- **DO NOT** stand on the footplates of the power wheelchair, while the wheelchair is in the seating position.
- **DO NOT** tow the wheelchair by other vehicles (cars, motorcycles or bicycles, etc.) Only use freewheel mode on flat surfaces since your electromagnetic brakes are not engaged in this mode, without these brakes it will roll down a hill causing injury or damage. Never drive under the influence of alcohol or medication.
- **DO NOT** sit in the powered wheelchair within a moving vehicle unless it has been affixed the labels of hook mark The labels of hook mark mean that the powered wheelchair fulfils the performance requirements for a “Crash Test” of ISO 7176-19 and is suitable to use as a seat in vehicles that have been adapted for this purpose.



WARNING:

- As of this date, the KP-80 series have NOT been tested for safety in collisions according to ISO 7176-19. Therefore, the KP-80 series cannot be used as seats in any vehicles. That is, KARMA recommends that users are NOT transported in any vehicle while seated in the wheelchair. In the case of accident or a sudden stop, the user could be thrown from the wheelchair and get injured. The suggested solution is to transfer the user from the wheelchair into a normal seat of the vehicle and to securely stow the wheelchair in a separate compartment.

RAMPS

- **DO NOT** climb, go up or down ramps or traverse slopes greater than the safe climbing angle for your model specified in section 9. When negotiating ramps, if the joystick is released while moving forward, the power wheelchair will roll backwards approximately one foot before the brake engages. If the joystick is released while in reverse, the power wheelchair will roll backwards approximately two and a half feet before the brake engages. When going uphill, always lean the trunk forward and do not change direction abruptly. When going downhill, always lean the trunk backward.

- Be sure to reduce your speed when driving on curved roads or making a turn; do not drive at full speed. Please drive at a slower speed so you have complete control of the wheelchair

ELECTRICAL

- Check to ensure that all electrical connections are secure at all times. Grounding Instructions: DO NOT, under any circumstances, cut or remove the round grounding prong from any plug. Some devices are equipped with three-prong (grounding) plugs for protection against possible shock hazards. Where a two-prong wall receptacle is encountered, it is the personal responsibility and obligation of the customer to contact a qualified electrician and have the two-prong receptacle replaced with a properly grounded three-prong wall receptacle/outlet in accordance with the National Electrical Code and local laws. Do not use an extension cord when charging your batteries. A risk of fire and /or electric shock could be encountered.

BATTERIES

- The warranty and performance specifications contained in this manual are based on the use of deep cycle sealed lead acid batteries. KARMA strongly recommends their use as the power source for this unit. (Refer to Section 6) Carefully read the battery and charger information prior to installing, servicing or operating your wheelchair

RAIN

- **DO NOT** leave your power wheelchair in a rain of any kind.
- **DO NOT** use your power wheelchair in a shower or leave it in a damp bathroom while taking a shower.
- **DO NOT** leave your power wheelchair in a damp area for any length of time.
- Direct exposure to rain or dampness could cause the power wheelchair to malfunction electrically and mechanically and may cause the power wheelchair to prematurely rust.

WEIGHT LIMITATION

- The maximum weight that can be carried, including goods, is stated beside "Max. User Weight" in Section 10. SPECIFICATIONS.



Figure 1

STAIRWAYS

- **DO NOT** attempt to move an occupied power wheelchair between floors using a stairway. (See Figure 1) Never try to overcome any obstacle higher than 50 mm.
- Use an elevator to move an occupied power wheelchair between floors. If moving a power wheelchair between floors by means of a stairway, the occupant **MUST** be removed and transported independently of the power wheelchair. Extreme caution is advised when it is necessary to move an **UNOCCUPIED** power wheelchair up or down stairs. Karma recommends disassembling the wheelchair and transporting the components independently up or down stairs. Make sure to use **ONLY** secure, non-detachable parts on each component for hand-held supports.
- **DO NOT** attempt to lift a power wheelchair by any removable (detachable) parts. Lifting by means of removable (detachable) parts may result in injury to the user or assistants or damage to the wheelchair.

ESCALATORS

DO NOT use an escalator to move a power wheelchair between floors. Serious bodily injury and damage to the wheelchair may occur.

YOU AND YOUR KARMA SERVICE PROVIDER

- No tools are required for assembly. Your wheelchair should be assembled by your authorized Karma dealer. Your authorized Karma dealer is also your service provider. Unauthorized repairs, upgrades, and add-ons will void your warranty. Anything wheelchair-related that requires tools should be performed by your authorized Karma service provider. Your Karma service provider has the necessary service manual for your wheelchair.
- If you have any defective parts or lose any parts, please contact your dealer for repair and/or replacement. Please only use parts authorized by Karma. Use of parts that are not authorized by Karma will void your warranty.
- Part numbers are listed on our bill of materials (explosion drawings), which we give to our authorized dealers and service providers. Customers should order parts through their dealer as well as all repairs and scheduled maintenance.
- Customers should go to their dealership for all service needs to guarantee their warranty is not void. Always go to an authorized service provider.
- Unauthorized repairs will void your warranty. Procedures other than those described in this manual must be performed by a qualified technician.
- They also have the service manual with a complete list of maintenance required to keep your Karma wheelchair in top performance. Check the warranty section of this manual to find out what Karma guarantees and what maintenance service and parts that are not covered by the warranty.
- Karma does not have an official list of service providers at this time. Please contact your dealer for service. If you cannot contact your dealer, please contact another authorized Karma dealer for service. If all else fails, contact Karma directly via our website or give us a call and we can refer you to your new service provider.

CLASSIFICATION & INTENDED USE

- The Ergo Stand series is classified as a Class A mobility product for indoor use. This wheelchair is suitable for users up to 135 kg in weight. It also has an extremely durable steel frame with tough accessory and does not suffer in dramatic extremes of temperature (neither user nor attendant need touch metal parts in normal use).
- The stand-up function operates exclusively on a flat surface, away from any stairs, access ramp or slope.
- Check with your local government as to legislation pertaining to mobility vehicles to assure your legal requirements to drive on public roads have been met, i.e. a safety belt, lighting, registration or licensing

CE MARKING

- This power wheelchair complies with the requirements of the Medical Devices Regulation (EU) 2017/745.

DECLARATION OF CONFORMITY



Document No.: DDC-KP-8-01

EU Declaration of Conformity

We, with the information specified in the below,

Our information as the manufacturer:

Manufacturer's Name: KARMA MEDICAL PRODUCTS CO., LTD

Manufacturer's Address: NO. 2363, Sec. 2, University Rd., Min-Hsiung Shiang, Chia-Yi County, 62144, Taiwan

SRN (Single Registration Number): TW-MF-000013206

Our authorized representative:

Name: KARMA MOBILITY, S.L.

SRN (Single Registration Number): ES-AR-000004852

Address: C/ PERIODISTA FRANCISCO CARANTOÑA
DUBERT, 23 Bajo
33209 GIJÓN – ASTURIAS, SPAIN

Contact Person: Raquel Yuste

Contact Information: (+34) 984 390 907

In accordance with

Regulation (EU) 2017/745 of the European Parliament and of the council Annex I, II, III, IV and IX

hereby declare that the medical device specified below:

Basic UDI-DI of Annex VI: 471987385KP-8LN

Device: Electrically powered wheelchair

Trade Name or Mark: Ergo Stand series

Model Number: KP-80

Product Code according to EMDN: Y122127

Product Code according to GMDN: 41877

Classification: Rule 1 of Class I

UDI-DI: 04719873856732

DECLARATION OF CONFORMITY



Document No.: DOC-KP-8-01

is in conformity with the applicable requirements of the following documents:

Ref. No.	Title	Edition date
ISO 13485	Medical devices - Quality management systems - Requirements for regulatory purposes	2016
ISO 14971	Medical devices - Application of risk management to medical devices	2019
EN 12182	Assistive products for persons with disability - General requirements and test methods	2012
EN 12184	Electrically powered wheelchairs, scooters and their chargers - Requirements and test methods	2014
EN 62366	Medical devices - Application of usability engineering to medical devices	2015
EN 60601-1	Medical electrical equipment - Part 1: General requirements for basic safety and essential performance	2006
EN ISO 10993-1	Biological evaluation of medical devices - Part 1: Evaluation and testing within a risk management process	2009
EN ISO 10993-5	Biological evaluation of medical devices — Part 5: Tests for in vitro cytotoxicity	2009
EN ISO 15223-1	Medical devices - Symbols to be used with medical device labels, labelling and information to be supplied - Part 1: General requirements	2016
MEDDEV. 2.7/1 Rev. 4	CLINICAL EVALUATION: A GUIDE FOR MANUFACTURERS	2016
MEDDEV 2.12/1 Rev. 8	GUIDELINES ON A MEDICAL DEVICES VIGILANCE SYSTEM	2013

The information on this declaration has been stated on the sole responsibility of KARMA MEDICAL PRODUCTS CO., LTD.

We hereby declare that the device named above has been designed to comply with the relevant sections of the above referenced specifications. The device complies with all General Safety and Performance Requirements.

Date of issue: 4th October 2021

Place of issue: NO. 2363, Sec. 2, University Rd., Min-Hsiung Shiang, Chia-Yi County, 62144,
Taiwan

Richard Chang, CEO

TABLE OF CONTENTS

1. PREFACE	1
2. SAFETY	2
2.1 BEFORE DRIVING.....	2
2.2 WHILE MOVING.....	3
2.3 ERGO STAND SERIES LABELLING	6
3. EMI/RFI	7
3.1 ELECTROMAGNETIC INTERFERENCE FROM RADIO WAVE SOURCES	7
4. ERGO STAND SERIES PARTS.....	11
5. OPERATION.....	13
5.1 JOYSTICK CONTROLLER.....	13
5.2 HOW TO OPERATE YOUR WHEELCHAIR.....	15
5.3 FREEWHEEL LEVERS.....	20
5.4 ADJUSTMENT.....	21
5.5 TRANSFERRING IN AND OUT.....	26
5.6 INSTRUCTIONS OF EMERGENCY DESCEND SWITCH.....	27
6. BATTERIES AND CHARGER	28
6.1 CHARGING THE BATTERIES	28
6.2 CHARGER.....	30
6.3 BATTERIES	30
6.4 CLEANING THE BATTERIES	32
6.5 REPLACING THE BATTERIES.....	32
7. INSPECTION AND MAINTENANCE.....	36
7.1 DAILY CHECK.....	36
7.2 WEEKLY CHECK.....	37
7.3 REGULAR MAINTENANCE RECORD.....	38
7.4 TIRES	39
7.5 GENERAL MAINTENANCE.....	39
7.6 TRANSPORTING AND STORING	40
7.7 BATTERY, CIRCUIT BREAKER AND TIRES	41
8. OPTIONAL ACCESSORIES	43

9. TROUBLE SHOOTING	46
9.1 TROUBLE OR PROBLEMS WITH YOUR WHEELCHAIR	46
9.2 VR2 CONTROLLER, BATTERY & DIAGNOSTICS INDICATOR.....	46
9.3 LINX CONTROLLER, BATTERY & DIAGNOSTICS INDICATOR	48
10. SPECIFICATIONS.....	50
11. CLEANING & RECYCLING.....	52
11.1 CLEANING	52
11.2 POST-CONSUMER RECYCLING	52
12. WARRANTY.....	54
12.1 SERIAL NUMBER	54
12.2 CONTENTS AND DURATION OF WARRANTY.....	54
12.3 THE CLAIMS FROM THIS WARRANTY SHALL NOT ARISE FOR THE FOLLOWING REASONS.....	55
12.4 THE RESPONSIBILITIES OF THE USER.....	55
12.5 THE RESPONSIBILITIES OF THE DEALER	55
12.6 TRANSFER OF WARRANTY RIGHTS	56

1. PREFACE



1.1 Please carefully read this owner's manual before using the wheelchair.

Improper use of the wheelchair could result in harm, injury or traffic accidents. Therefore, for safe and enjoyable use of the wheelchair, please read this owner's manual.

1.2 This owner's manual includes operation instructions for the aspects of the wheelchair, assembly instructions, and instructions on how to deal with possible accidents.

1.3 This owner's manual is written for Karma power stand-up wheelchair(s): Ergo Stand Series.

1.4 The symbols used in this manual are explained below. Pay special attention to the parts marked with these symbols.

 WARNING:	Improper use could lead the user to severe injury or death.
 CAUTION:	Improper use could lead the user to severe injury and/or damage to your wheelchair.
 SUGGESTION:	Follow these instructions to keep the wheelchair in good condition.

1.5 This manual includes the repair and maintenance chart as well as the Warranty. Please keep it in a safe place or with the wheelchair. If someone else uses the wheelchair, make sure that you give him or her this owner's manual for his or her reference.

1.6 As designs change, some illustrations and pictures in this manual may not correspond to the vehicle that you purchased. We reserve the right to make design modifications without further notice



CAUTION:

- When prescribing wheelchairs for use by full or partial amputees (above or below knee, single or double) or other conditions that affects the user's natural centre of gravity and might cause the wheelchair to tip or the person on the wheelchair to fall off, we suggest contacting your therapist or dealer as well as attaching anti-tippers, pelvic belt, or other additional safety accessories.
- When using the wheelchair, ALWAYS follow the Highway Code when outdoors and the guidelines written in this manual.

2. SAFETY

2.1 Before Driving

2.1.1 The user must be familiar with the use and operation of this wheelchair before driving.

2.1.2 Therefore, please always keep these safety guidelines in mind

2.1.3 Traffic Rules

2.1.3.1 Pedestrian traffic rules apply to this wheelchair. Please be safe.

Drive only on pedestrian areas such as the sidewalk. Never drive the wheelchair on the highway.

2.1.3.2 Be aware of other vehicles when crossing all roads.

2.1.3.3 Be extremely cautious when driving your wheelchair in heavy traffic or the shopping mall.

2.1.3.4 DO NOT drive your wheelchair when you feel tired or consume alcohol.

2.1.3.5 Please do not drive your wheelchair at night.

2.1.3.6 Please follow pedestrian traffic lights.

2.1.4 Practice Driving

2.1.4.1 Before you are familiar with the operation of your wheelchair please practice in a wide and open area, like a park. To avoid falling off your wheelchair please practice all kinds of driving motions, such as accelerating, stopping, turning, reversing and going up and down ramps. Please set the speed to medium

when you first start practicing. Be safe. Make sure someone accompanies you in case you need assistance.

2.1.4.2 Be sure you are able to control and operate your wheelchair easily and confidently before you move the speed higher.

2.1.5 No Passengers

2.1.5.1 KARMA wheelchairs are limited to one single driver. Do not carry passengers (including children) on your wheelchair.

2.1.6 No Hauling Heavy Goods

2.1.6.1 Do not use this wheelchair to carry or haul heavy goods.

2.1.6.2 The maximum weight that can be carried, including goods, is stated beside "Max. User Weight" in Section 10. SPECIFICATIONS.

2.1.7 RAIN

2.1.7.1 This product is not guaranteed to be water resistant. Please do not drive in the rain, through puddles or spray water to clean this product.



Figure 2.1

2.2 While Moving

2.2.1 Please carry out daily inspections. Refer to Section 7.1 Daily Check.

2.2.2 General Warning

2.2.2.1 Do not lean over the side of the wheelchair as such an action may cause you to lose balance and fall. Use caution to assure your clothing doesn't get tangled with the wheels.

2.2.3 Railroad Crossing

2.2.3.1 Before crossing the tracks, please stop completely and look both ways. Cross the tracks perpendicular to avoid your wheels getting stuck.

2.2.3.2 Do not drive at full speed over railroad tracks.

2.2.4 Circumstances to Avoid

2.2.4.1 Avoid roads with heavy traffic, mud, excessive gravel or bumps, snow and ice. These conditions may damage your wheelchair. Avoid roads that are too narrow or by a canal/waterway without any fence/hedge. Also avoid places where your wheels might

get stuck, slip or not have traction. Do not drive in a gale, at night or in rainy/snowy/foggy/misty weather. These conditions may cause your wheelchair to rust. (See Figure 2.2)

2.2.4.2 Do not drive in an S curve, do doughnuts or make sudden turns.

2.2.4.3 Do not take an escalator.

2.2.5 Mobile Phones and Other Electric Equipment

2.2.5.1 Do not use a mobile phone or other wireless communication devices while driving. (See Section 3. EMI/RFI)

2.2.5.2 Do not charge the mobile phone or other electric devices from your wheelchair's batteries.

2.2.6 Ramps, Inclines and Drops

2.2.6.1 Do not drive onto a steep ramp. Refer to "Max. Safe Slope" in Section 10- SPECIFICATIONS for your wheelchair's safe climbing angle.

2.2.6.2 When climbing up a slope, please set the speed higher than the medium speed and drive carefully. (See Figure 2.3) When going down a slope, set the speed to "1" and never use reverse.

2.2.6.3 Do not drive on a road with many bumps and holes close to each other, such as potholes or washboard roads. (See Figure 2.4)

2.2.6.4 Do not make sudden turns when driving on gravel roads or ramps.

2.2.6.5 The maximum surmountable obstacle height (maximum obstacle climbing ability) is 5 cm for your wheelchair. Exceeding this obstacle height will damage your wheelchair and void your warranty. (See Figure 2.5)

2.2.6.6 When negotiating an obstacle slow down, put your seat into the full upright position and approach it head on (perpendicular). Just before the obstacle, speed up until the entire wheelchair has conquered the obstacle. Negotiating an obstacle at an angle may cause your wheelchair to tip over. Don't do it!

2.2.6.7 When climbing down a curb, slow down just before you get to it and only speed up after the entire wheelchair has lowered to the road. Again, descending obstacles should be done perpendicularly. (See Figure 2.6)

2.2.6.8 Karma does not design wheelchairs to take jumps over or off obstacles. Doing so will void your warranty.

WARNING:

- Do not set the wheelchair in freewheel mode when on an incline or decline. If you breakdown on railroad tracks, first, check for an oncoming train. If a train is coming, get out of its way immediately! If no train is coming, set it as freewheel mode and push the wheelchair off the tracks.

2.2.7 Maximum User Weight Limit

2.2.7.1 Refer to "Max. User Weight" in Section 10. SPECIFICATIONS.

Loads exceeding maximum capacity can damage your wheelchair and cause malfunctions yielding a safety hazard. The warranty does not cover damage caused by improper operation of the wheelchair.



Figure 2.2



Figure 2.3



Figure 2.4



Figure 2.5



Figure 2.6

2.2.8 Service life

The expected service life of the product is **five years**, presuming that the product is used daily in accordance with the safety operation instructions, inspection and maintenance instructions, and intended use, which described in this manual.

2.3 Ergo Stand Series Labelling

Please carefully read all the labelling on the wheelchair before driving it. Do not remove them. Protect them for future reference.

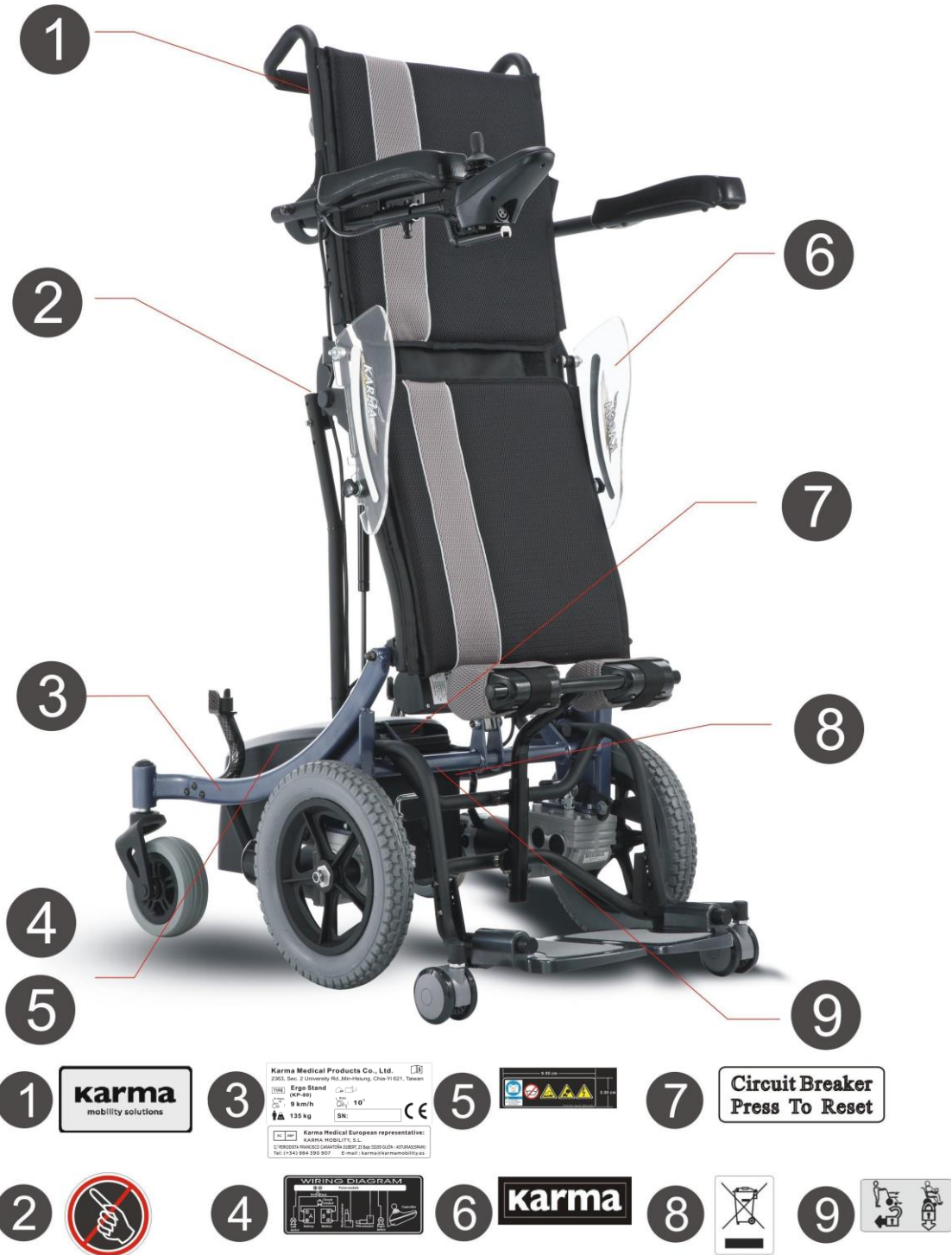

3. EMI/RFI

This section provides the user with basic information about the problems with EMI, known sources of EMI and protective measures either to reduce the possibility of exposure or to minimize the degree of exposure. This section also shows some conditions in which unexpected or erratic wheelchair movements may occur.



CAUTION:

- It is very important that you read this information regarding the possible effects of electromagnetic interference on your electric KARMA wheelchair.

3.1 Electromagnetic Interference from Radio Wave Sources

Powered vehicles may be susceptible to electromagnetic interference (EMI), which is interfering electromagnetic energy (EM) emitted from sources such as radio stations (Radio Frequency Interference), TV stations, amateur radio (HAM) transmitters, two-way radios, and cellular phones. The interference (from radio wave sources) can cause the powered vehicle to release its brakes, move by itself, or move in unintended directions. It can also permanently damage the powered vehicle's control system. The intensity of the interfering EM energy can be measured in volts per meter (V/m). Each powered vehicle can resist EMI up to a level of intensity. This amount of resistance is called its immunity level. The higher the immunity level is, the greater the protection will be. At this time, current technology is capable of achieving at least a 20 V/m immunity level, which would provide useful protection from the more common sources of radiated EMI. This powered vehicle model, with no further modification, has an immunity level of 20 V/m without any accessories.

There are a number of sources of relatively intense electromagnetic fields in our everyday environment. Some of these sources are obvious and easy to avoid. Others are not apparent and exposure could be unavoidable. However, we believe that by following the warnings listed

below, your risk to EMI can be greatly minimized.

3.1.1 The sources of radiated EMI can be broadly classified into three types:

3.1.1.1 Hand-held portable transceivers (transmitter-receivers) with the antenna mounted directly on the transmitting unit, such as citizens band (CB) radios, walkie-talkies, security and fire or police transceivers, cellular telephones and other personal communication devices;

NOTE:

Some cellular telephones or similar devices transmit signals while they are ON, even though they are not in use.

3.1.1.2 Medium-range mobile transceivers used in police cars, fire trucks, ambulances and taxis usually having the antenna mounted on the outside of the vehicle; and

3.1.1.3 Long-range transmitters and transceivers, such as commercial broadcast transmitters (radio and TV broadcast antenna towers) and amateur (HAM) radios.

NOTE:

Other types of hand-held devices (cordless phones, laptop computers, AM/FM radios, TV sets, CD players, cassette players, and small appliances such as electric shavers and hair dryers, et cetera) so far as we know, are not likely to cause EMI problems.

3.1.2 Powered Vehicle Electromagnetic Interference (EMI)

3.1.2.1 Because EM energy rapidly becomes more intense as one moves closer to the transmitting antenna (source), the EM fields from hand-held radio wave sources (transceivers) are of special concern. It is possible to unintentionally bring high levels of EM energy too close to the powered vehicle's control system while using these devices. This can affect your powered vehicle's movement and braking. Therefore, the warnings listed below are recommended to prevent possible interference with the control system of the powered vehicle.

3.1.3 Warnings

3.1.3.1 Electromagnetic interference (EMI) from sources such as radio and TV stations, amateur radio (HAM) transmitters, two-way radios and cellular phones can affect powered vehicles and motorized wheelchairs. Following the warnings listed below should reduce the chance of unintended brake release or powered vehicle movement that could result in serious injury.

3.1.3.1.1 Do not operate hand-held transceivers-receivers such as citizens band (CB) radios or turn ON personal communication devices such as cellular phones, while the powered vehicle is turned ON.

3.1.3.1.2 Be aware of nearby transmitters, such as radio or TV stations, and try to stay away from them.

3.1.3.1.3 If unintended movement or brake release occurs, turn the powered vehicle OFF as soon as it is safe.

CAUTION:

- Some stores may have automatic (sensor) doors and alarm systems set at certain frequencies that might affect your power wheelchair.

3.1.3.1.4 Be aware that adding accessories/components or modifying the powered vehicle may make it more susceptible to EMI. There is no easy way to evaluate their effect on the overall immunity of the powered vehicle.

3.1.3.1.5 Report all incidents of unintended movement or brake release to your powered vehicle dealer or KARMA, and note whether there was a source of EMI nearby.

3.1.4 Important Information

3.1.4.1 20 Volts per meter (V/m) is a generally achievable and useful immunity level against EMI (the higher the level is, the greater the protection will be.)

3.1.4.2 This product has an immunity level of 20 V/m without any accessories connected to it.

4. Ergo Stand Series Parts

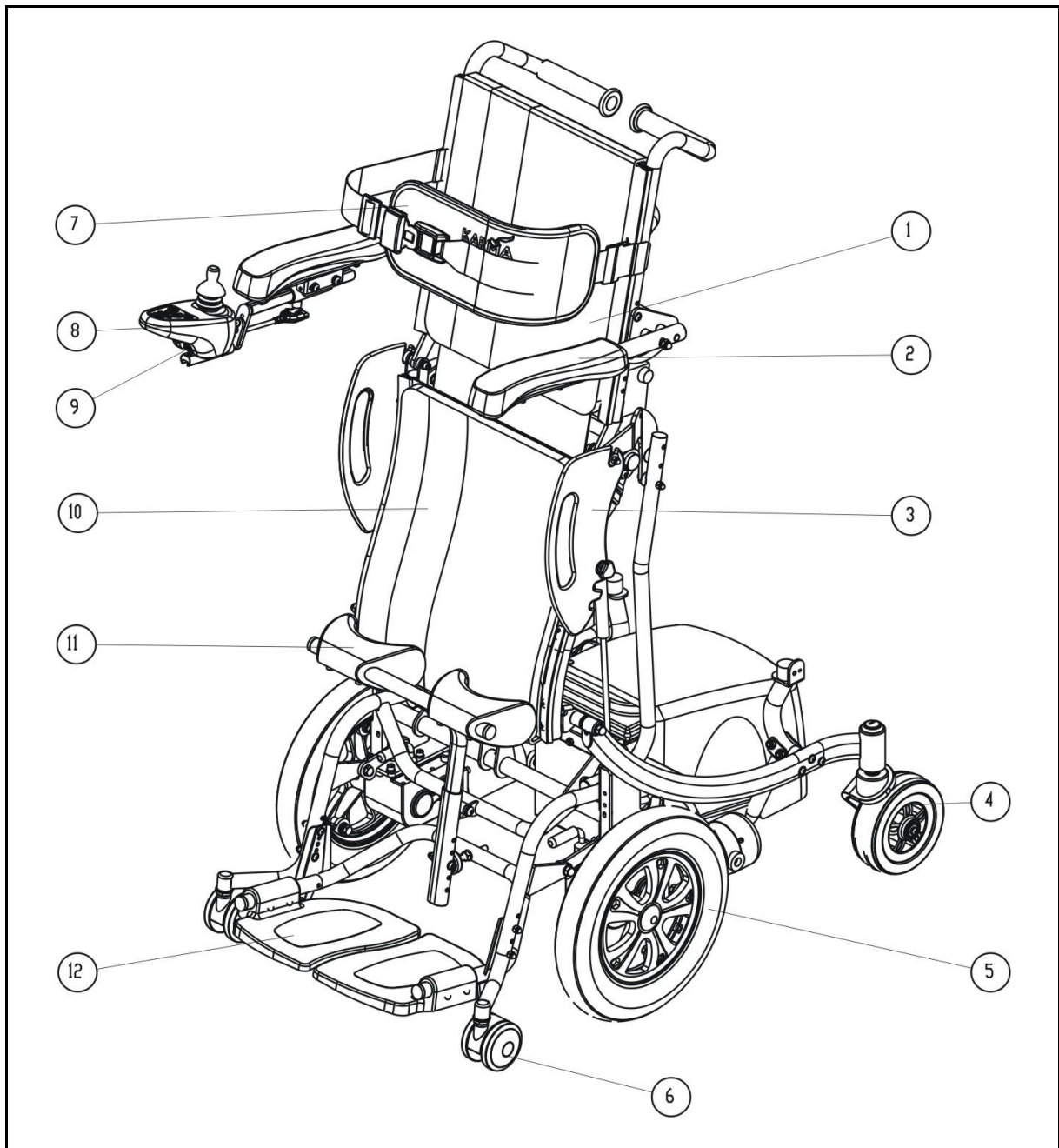

1. Back Support

2. Arm Support

3. Side Panel

4. Rear Wheel

5. Drive Wheel

6. Front Small Wheel

7. Chest Strap

8. Controller

9. Charging Socket

10. Seat

11. Knee Support

12. Foot Support

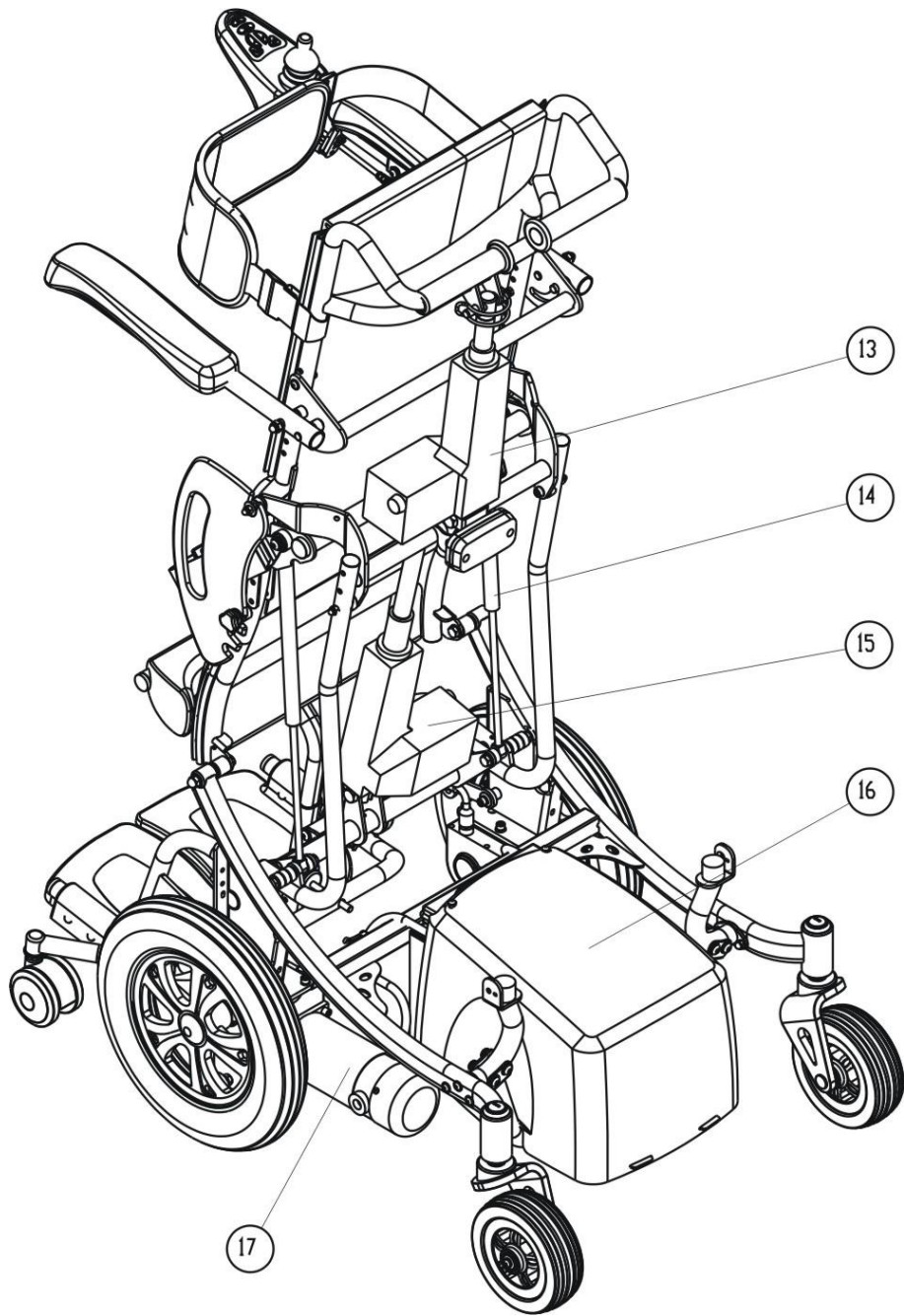

- 13. Back Reclining Actuator
- 14. Gas Strut
- 15. Stand-up Actuator
- 16. Battery Pack & Power Module
- 17. Motor

5. OPERATION

5.1 Joystick Controller

- VR2 Joystick Controller

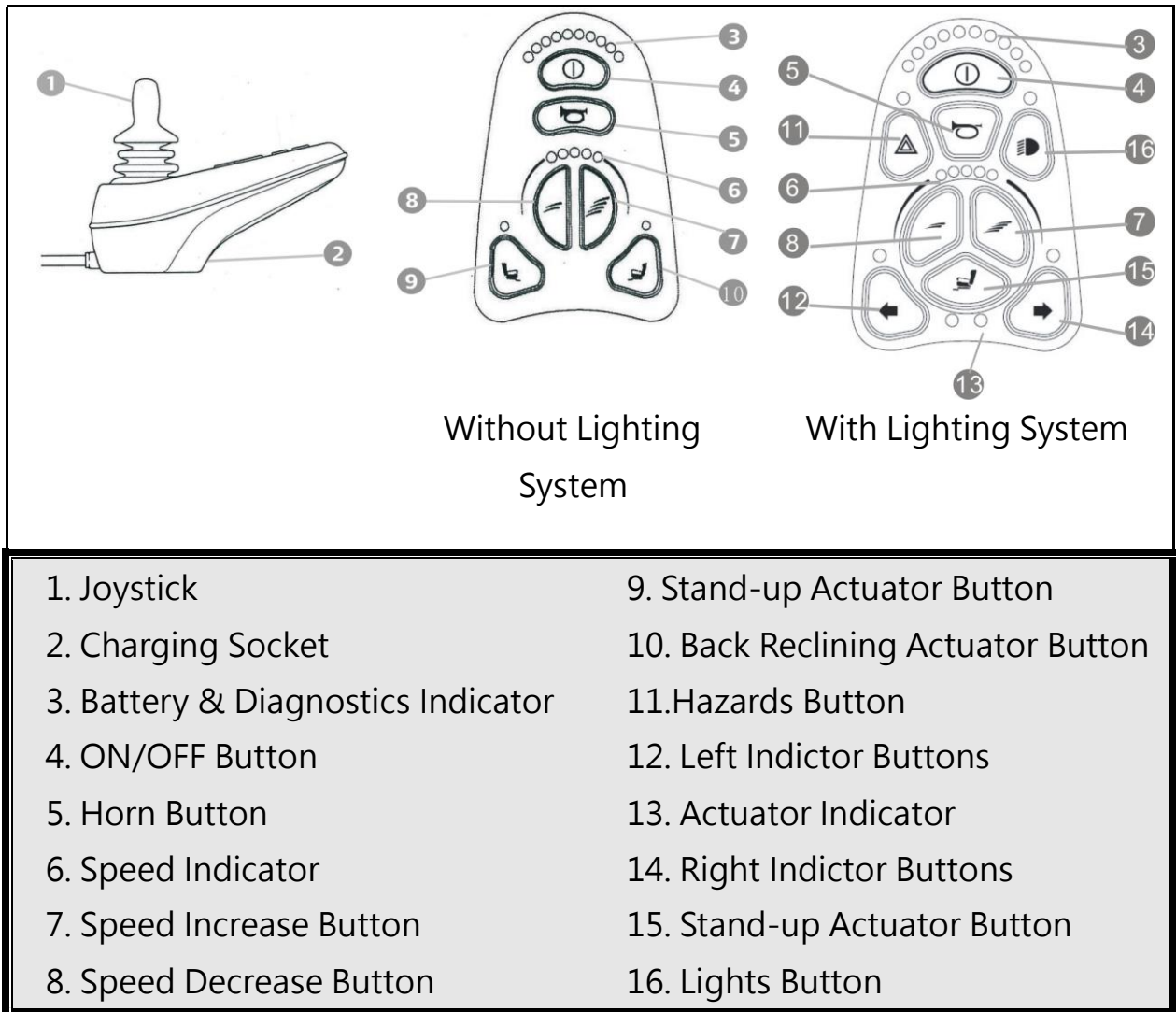

- LiNX Joystick Controller



1. Joystick	5. Horn Button	10. Drive/ Actuator Status
2. Charger Socket	6. Speed dial	11. Drive Function Selector
3. Battery Gauge	7. Headlight & Taillight/ Right Indicator Button	12. Drive Function Indicator
4. Power Button/ Status Indicator	8. Hazard Light/ Left Indicator Button	13. Bluetooth Connectivity Indicator
	9. Seat Function Selector	

5.2 How to Operate Your Wheelchair

5.2.1 Power ON/OFF

● VR2 Joystick Controller

Press the power button. Be sure not to touch the joystick while turning on the controller. Your battery & diagnostics indicator should light up.

● LiNX Joystick Controller

To switch ON the system, press the power button. If there is no fault with the system, the status indicator will light up green, and the battery gauge will display the current battery status. To switch OFF the system, press the power button. The system will power down and the status indicator will switch off.

5.2.2 Driving Speed Adjustment

● VR2 Joystick Controller

The speed increase/decrease button allows you set various forward and reverse speeds. The settings are a percentage of maximum power. Notice the orange dots on the speed indicator. The more orange dots, the faster your speed.

You can choose between 1 to 5 orange dots in the speed indicator, with 5 being the maximum speed. Please refer to "Max. Speed" in Section 10.

SPECIFICATIONS.

Speed Scale	Speed Equivalencies and Recommended Circumstances
1-2	Speed equivalent to walking slowly on foot On an decline Driving indoors or in a narrow space
3-4	Equivalent to walking at a normal speed
5	Driving in an open space On an incline

● LiNX Joystick Controller

The speed dial allows the user to limit the maximum speed of the wheelchair to suit their preference and environment. The speed dial offers 10 discrete steps between the lowest speed and the highest speed.

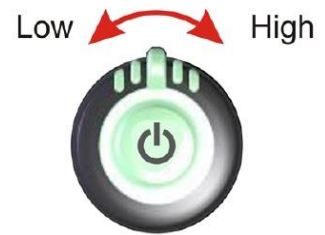

⚠ CAUTION:

- Please slow down before you get used to control your power wheelchair.
- Please slow down your speed when indoors.

5.2.3 Forward, Reverse and Braking

5.2.3.1 Push forward on the joystick to make the wheelchair move forward.

5.2.3.2 Pull back on the joystick for the wheelchair to move backward.

5.2.3.3 Release the joystick and the wheelchair will quickly slow down, the electromagnetic brake will be activated to stop the wheelchair.

5.2.3.4 Come to a complete stop before turning the power OFF.

⚠ CAUTION:

- The stopping distance will vary with your forward/reverse speed. Therefore, please gradually slow down and come to a complete stop well before any obstacles or danger.
- To park the wheelchair, be sure to park on flat ground and then turn the power to OFF.
- NEVER use the freewheel mode when going down an incline. The electromagnetic brake won't function in freewheel mode.

5.2.4 Horn Button

● VR2 Joystick Controller

The horn will sound for the duration of time the button is pressed.

- **LiNX Joystick Controller**

Press the horn button to sound the horn. The horn will sound for as long as the horn button is pressed.



- 5.2.5 Battery Indicator

- **VR2 Joystick Controller**

When the power is turned on, the battery indicator will light up with a possible total of three red, four orange and three green dots indicating the remaining power of the batteries. All of the green lights being lit indicate that the batteries are fully charged. If only the red dots are lit, this indicates that the batteries are out of (or nearly out of) power.

- **LiNX Joystick Controller**

The battery gauge comprises five different LEDs. The number of LEDs lit depends on the status of the battery, as shown below. The battery gauge LEDs are also used to display charging information.

Battery Gauge	Battery Level
	Fully charged
	Consider charging battery
	Battery needs charging

5.2.6 Instructions of Fastening the Controller Cable

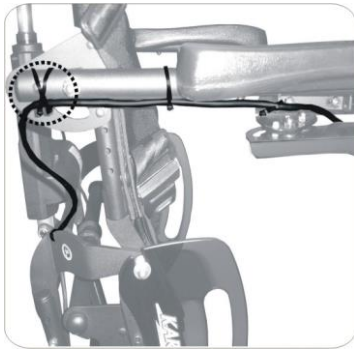

1. Please use the X way to fasten the cable tie.

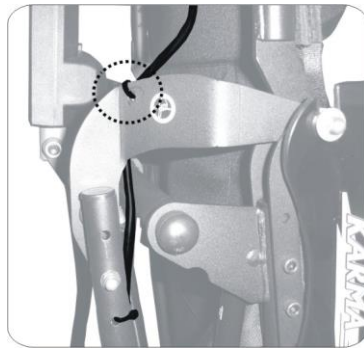

2. To pack the chair into a carton, the circled place is not fastened by the cable tie. Please fasten it with a cable tie as soon as you unpack the chair.

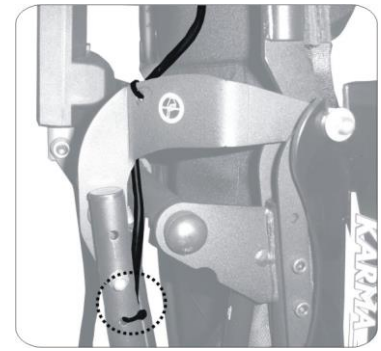

3. Please note the cable in the circled position should be always kept on the direction (face forward, as shown above).

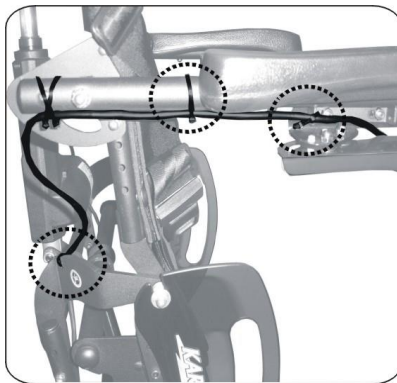

3. Please use the cable tie to fasten it.

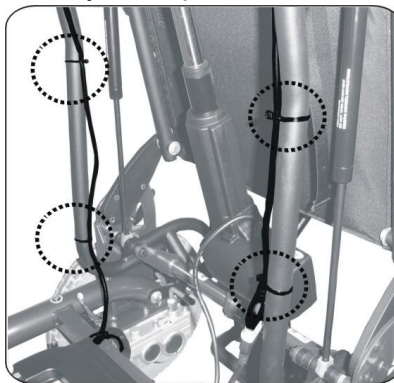

4. Please use the cable tie to fasten it. The cables should be fixed at the inner side of the two tubes.

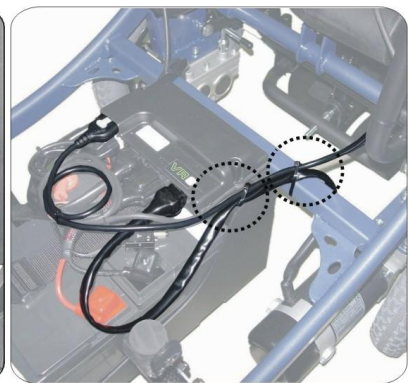

5. Please use the cable tie to fasten it.

SUGGESTION:

- It is recommended that you charge the batteries immediately when the battery indicator shows only three or less red dots.
- After charging or replacing new batteries, drive the wheelchair for 2-3 minutes to make sure the batteries are fully charged before going on a long journey
- In wintertime, the batteries may respond slowly and the drive range may also be reduced. You must store your wheelchair indoors above freezing

temperatures.

- When driving on an incline, the battery indicator light might move up and down. This is normal.
- Even if the batteries are used properly their capacity will decay over time, thereby reducing the drive range (maximum distance travelled per full charge). Thus, when the drive range becomes about 50% of what brand new batteries would offer, it's time to replace them with new batteries. Otherwise, the batteries may die unexpectedly leaving you in a possibly precarious situation.
- The drive range will be shortened when driving frequently on slopes or uneven ground, as this consumes more battery power.

5.2.7 Stand-Up Function Operation

● VR2 Joystick Controller

5.2.7.1 Turn the power on.

5.2.7.2 Press the stand-up actuator button 9. (See 5.1 VR2 Joystick Controller)

5.2.7.3 Moving the joystick forward will stand up the seat in that direction.

5.2.7.4 Moving the joystick backward will sit down the seat in that direction.

● LiNX Joystick Controller

5.2.7.5 Turn the power on.

5.2.7.6 Press the seating function select button 9. (See 5.1 LiNX Joystick Controller)

5.2.7.7 The selected seating function is displayed on the drive/ actuator status indicator.

5.2.7.8 Moving the joystick forward will stand up the seat in that direction.

5.2.7.9 Moving the joystick backward will sit down the seat in that direction.



5.2.8 Back Reclining Function Operation

● VR2 Joystick Controller

5.2.8.1 Turn the power on.

5.2.8.2 Press the stand-up actuator button 10. (See 5.1 VR2 Joystick Controller)

5.2.8.3 Moving the joystick backward will recline the back in that direction.

● LiNX Joystick Controller

5.2.8.4 Turn the power on.

5.2.8.5 Press the seating function select button 9. (See 5.1 LiNX Joystick Controller)

5.2.8.6 The selected seating function is displayed on the drive/ actuator status indicator.

5.2.8.7 Moving the joystick backward will recline the back in that direction.



CAUTION:

- The maximum speed will reduce to half while the stand-up function is operated.
- The stand-up function exclusively on a flat surface, away from any stairs, access ramp or slope.
- While operate the stand-up function should keep the fingers or clothes away from seat bottom to reduce squeeze hazards.
- Before the stand-up function operation ensure that the chest strap and knee support are fitted securely.

SUGGESTION:

- Lubricate the sliding parts or pivots 1 to 2 times per month.

5.3 Freewheel Levers

The Ergo Stand series is supplied with freewheel levers to allow for manual pushing of the power wheelchair if required.

5.3.1 To select neutral from the engaged position:

Rotating the levers located on the top of both motors forward. The wheelchair will now roll freely. (See Figure 5.3.1)

5.3.2 To engage the motors from the neutral position:

Rotating the levers backward the gear will engage. (See Figure 5.3.2)

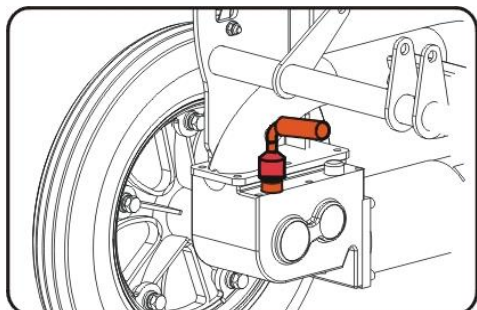

Figure 5.3.1

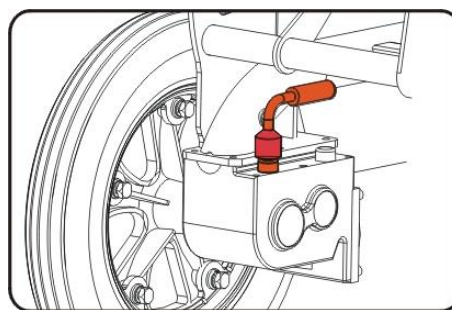

Figure 5.3.2



CAUTION:

- Always ensure that the freewheel levers are engaged before you turn on the controller.

5.4 Adjustment

5.4.1 Foot Support

5.4.1.1 Height Adjustment (7 different

positions) Remove the screws from the front tube of frame, put the foot support on the desired height and put back the screws. Tighten securely. (See Figure 5.4.1)



Figure 5.4.1

5.4.1.2 Swing Outward In order to transfer in or out easy, the separate foot support can be lift up separately. (See Figure 5.4.2 and Figure 5.4.3)



Figure 5.4.2

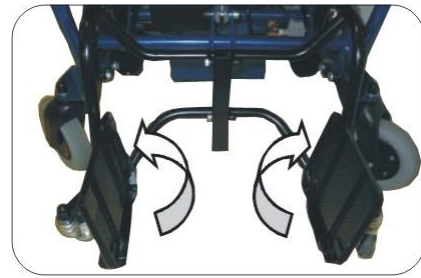

Figure 5.4.3



CAUTION:

- Adjust the height of the foot support according to the length of the user's leg.
- Remember that adjusting the foot support at the right height means a better pressure relief along the thigh in a seated position.

5.4.2 Arm Support

5.4.2.1 Height Adjustment (Five different positions) Remove the screws from the back support tube, adjust it to the desired height and put back the screws. Re-tighten them securely. (See Figure 5.4.4).



Figure 5.4.4



Figure 5.4.5

5.4.2.2 Swing Backward

To make side transfer easy, the chair is equipped with swing away arm support. Lift and swing backward to remove. (See Figure 5.4.5)

5.4.3 Knee Support

Before standing, it is important to adjust the knee support in depth and height and to adjust the u-formed knee supports in the angle and width.

5.4.3.1 Adjustment in the Depth

Screw or unscrew the adjusting bolt until you have reached the desired depth. Keep 3 to 4 cm between the knee of the user and

the knee support. (See Figure 5.4.6)

5.4.3.2 Adjustment in Height (Three different height)

To adjust, remove bolt, slide knee support to desired height and put the bolt back. Tighten securely. The upper edge of the knee support has to be below the patella. (See Figure 5.4.7)

5.4.3.3 Angle Adjustment

Loosen the fitting screws from the knee support and proceed with angle adjustment according to the morphology of the user. (See Figure 5.4.8)

5.4.3.4 Adjustment in the Width

Loosen up the fitting screws from the knee supports and proceed with width adjustment right and left within the tube limits.

Once adjusted, tighten up the screws securely. (See Figure 5.4.9)

Those adjustments will have to be optimized after a progressive standing session. This will enable to avoid exaggerated pressure on the knees and to guarantee a good alignment of the limbs.



Figure 5.4.6



Figure 5.4.7



Figure 5.4.8

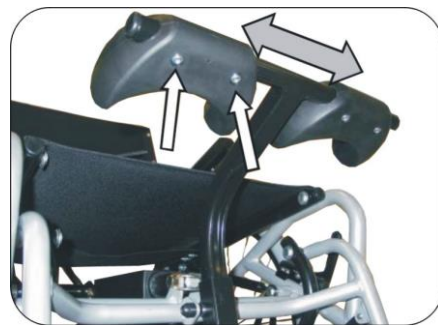

Figure 5.4.9

5.4.4 Chest Strap (See Figure 5.4.10)

5.4.4.1 The chest strap can be fitted at two different heights between the upholstery fastening strip and backrest tube.



Figure 5.4.10



Figure 5.4.11

5.4.4.2 To adjust the height, remove the screw, put the chest strap to the desired height and put the screw back.



WARNING:

- Make sure that the chest strap does not get caught in the spokes when it releases.
- This chest strap is not to be used as a safety belt in a vehicle.
- The chest strap should be fitted below the armpit and should not loop the arm over trunk in order to avoid the hazard causing by the trunk slipping down. (See Figure 5.4.11)

5.4.5 Seat depth

5.4.5.1 To determine the optimum seat depth, specific attention to the user' s upper leg length, lower extremity range of motion measures, posture and flexibility is necessary.

5.4.5.2 Adjusting the seat depth: loosen and remove the bolts from the seat frame on each side (two bolts from the upper part, and one bolt from the lower part), as shown in the figure below.

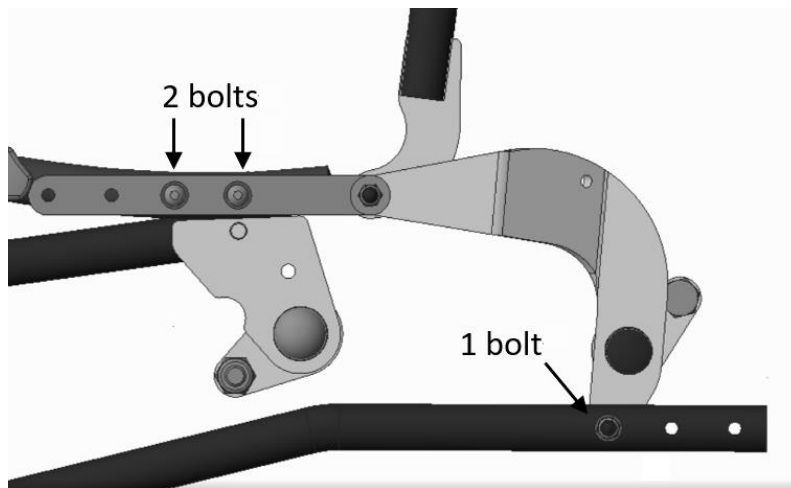

5.4.5.3 There are 3 levels of seat depth adjustment: 40cm, 44cm & 48cm. The figures below show the seat depth set-up positions and can be referenced for making adjustments.

	Seat depth		
	48cm Upper hole: 1,2 Lower hole: 3	44cm Upper hole: 2,3 Lower hole: 2	40cm Upper hole: 3,4 Lower hole: 1
Reference position			

Figure 5.4.12

5.4.5.4 Put the bolts back and tighten them.

!
CAUTION:

- Only authorized personnel are allowed to make adjustments.
- After seat depth adjustment is completed, confirm the following information:
 - *The bolts are properly tightened as per figure 5.4.12.
 - *The rear wheel axle is maintained in a proper position and does not affect the stability of the wheelchair. If not, please readjust the rear wheel axle position.



SUGGESTION:

- The choice of seat depth influences manoeuvrability and access to motor vehicles.
- Make sure the back of your knees do not touch the seat bottom, as this is bad for your knees and circulation.

5.5 Transferring In and Out

5.5.1 Transferring In

5.5.1.1 Turn off the power and engage the parking brake.

5.5.1.2 Flip-up the foot support.

5.5.1.3 Lower the occupant into the seat, and use the arm support for support.

5.5.1.4 Restore the foot support.

5.5.2 Transferring Out

5.5.2.1 Make sure that the chair is near your final destination.

5.5.2.2 Turn off the power and engage the parking brake.

5.5.2.3 Flip-up the foot support or/and arm support.

5.5.2.4 Move your body to the destination.



CAUTION:

- Never stand on the foot support when getting in or out of the chair.

5.6 Instructions of Emergency Descend Switch.

5.6.1 Please refer to the figure below. One yellow Emergency Switch is equipped under the left (or the right) armrest. In the case of a controller failure causing the seat cannot be lowered to the seating position, press this Emergency Descend Switch to activate the actuator to lower the seat. It prevents the user from standing for a long period of time should the controller is faulty.

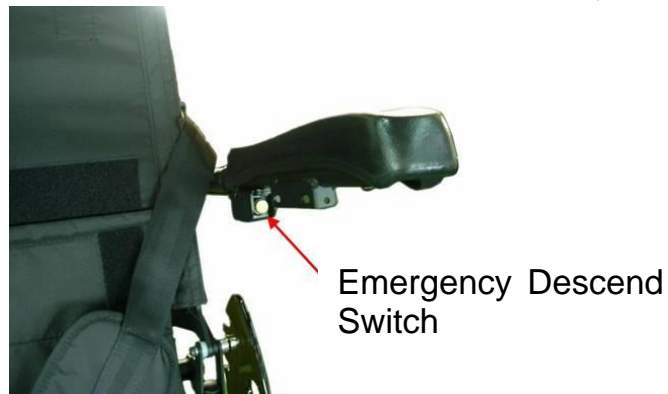

5.6.2 Descend Alert

To prevent any kid or other person from having their hands near the moving structure when the seat is descending, when the seat is lowering, there's an alert sound. No alert will sound when the seat is elevating.

6. BATTERIES AND CHARGER



CAUTION:

- Before you attempt charging, ensure you read and understand the instruction manual supplied with the battery charger, and you choose the correct input voltage for battery charger.

6.1 Charging the Batteries

Charge your batteries if any of the following conditions occur.

- 6.1.1 If you have used your wheelchair for more than an hour continuously;
- 6.1.2 You've used more than one third of the total charge;
- 6.1.3 When you haven't used the wheelchair for more than two weeks;
- 6.1.4 If the current charge is not enough to reach your final destination.
- 6.1.5 Be sure to follow the procedures precisely listed below.
- 6.1.6 Turn the wheelchair OFF.
- 6.1.7 Connect the charger's cord to a power outlet.
- 6.1.8 Connect the charger's plug to the charging socket.
- 6.1.9 The charging time is at least 6 hours, but it could be as long as 10 hours, depending on the status of the batteries and temperature.
- 6.1.10 When the charging is completed, disconnect the cord and pull out the round plug from the charging socket.



SUGGESTION:

- Do not disconnect the charger cord if the charging is not completed. The battery life will be seriously shortened or decayed if the batteries are repeatedly used without being fully charged. Therefore, be sure to always charge the batteries fully.
- Always complete the charging by letting the charge LED light turn green. NEVER stop charging before it is complete.
- When finished charging, disconnect the charger plug from the charging socket as soon as possible. Even when the charger is turned OFF, the electric power will slowly discharge if the cord is not disconnected. DO NOT leave the charger ON connected to the wheelchair for more than 24 hours.
- Charging time depends on the surrounding temperature; it takes longer in

the winter.

 **CAUTION:**

Please follow the guidelines below to avoid accidents while charging.

- Be sure to only use a KARMA approved battery charger and charge the battery completely every time. The battery can be damaged if a non-genuine charger is used.
- Never disassemble or modify the charger. This will void the warranty.
- Please charge in a well-ventilated area where the battery is not directly exposed to sunlight. Do not charge the battery under rainfall, in morning dew or in an area where the humidity is high.
- Do not cover the wheelchair with any waterproof cloth or other objects while charging. Don't charge in temperatures less than -10°C (14°F) or higher than 50°C (122°F) as the charger may not work well and the battery may become damaged.
- The charger is not guaranteed to be water resistant.
- Valve Regulated Lead-Acid batteries do not have a memory function like cell phone batteries have. Please get in the habit of recharging your VRLA batteries frequently.
- New batteries MUST be fully charged prior to initial use of the power wheelchair.
- Always charge new batteries before initial use or battery life will be reduced.
- As a general rule, recharge batteries as frequently as possible to assure the longest possible life and to minimize required charging time. Plan to recharge them when use of the power wheelchair is not anticipated.

 **WARNING:**

- Keep your wheelchair away from flammable objects while charging, as it may lead to fire or explosion of the battery.
- Since the battery may produce hydrogen, do not smoke while charging and charge in a well-ventilated area.
- Never connect or disconnect the plug (cord) with wet hands or if the plug (cord) is wet to avoid possible electric shock.

- Never attempt to recharge the batteries by attaching cables directly to the battery terminals or clamps. DO NOT jump start your wheelchair!
- Do NOT attempt to recharge the batteries while the power wheelchair is in operation.

6.2 Charger

The battery charger supplied by Karma is for indoor use only, and it must be protected from moisture and external heat source.

CAUTION:

- Before charging, make sure to set the 115V ↔ 230V switch to match the local AC voltage.
- If the switch is improperly set to a lower or higher voltage position, it will cause damage to the charger, and battery, Change the 115V ↔ 230V switch settings only when charger is disconnected from AC line voltage.

WARNING:

- The fan inside the charger will start to work when you turn on the charger. (8A, will start to work as temperature is over 50°C and stop running under 50°C)
- If you find that the fan does not function properly, DO NOT use the charger. Otherwise, the charger may overheat and start a fire.

6.3 Batteries

6.3.1 Do not expose the batteries to temperatures below -10°C (14°F) or above 50°C (122°F) when charging or storing the vehicle. Exceeding the specified temperature range can lead to either freezing or overheating of the batteries. This will damage the batteries and shorten their lives.

6.3.2 The batteries used on your wheelchair are maintenance free sealed lead acid batteries.

6.3.3 Thus, it is not necessary to change or refill the battery liquid.



WARNING:

- Do not open the battery seal cap at any time.
- After ANY adjustments, repair or service and BEFORE use, make sure that all hardware is tightened securely. Otherwise, injury or damage may occur.
- When removing/installing batteries, keep all foreign objects, especially metal, away from battery terminals.
- There are many risks involved with improper disposal of batteries, whether damaged or not. Batteries may contain heavy metals and be considered hazardous waste.
- Many regions around the world now strictly enforce laws to help protect our environment. By not disposing of batteries properly, you may be liable for fines from your local through national government.
- By not recycling batteries, they end up in landfills that are already low on space. From these landfills, lead and other chemicals may leach into streams and rivers destroying ecosystems and poisoning local water resources.
- Improper disposal of batteries may also cause injury to unsuspecting others that come in contact with them. If you come in contact with fluids or corroded powder from a battery, rinse with water and contact a physician if necessary. If contact with eyes occurs, rinse for 15 minutes and then visit a physician.
- Incinerating or burning a battery will cause it to explode! Please see the end of Section 11. Cleaning & Recycling for more information.
- Do not use an extension cord when charging your batteries.
- A risk of fire and /or electric shock could be encountered.



CAUTION:

- Place the power wheelchair in a well-ventilated area where work can be performed without risking damage to carpeting or floor covering.
- Failure to use the correct battery size and/or voltage may cause damage to the power wheelchair and give unsatisfactory performance.

6.4 Cleaning the Batteries

If a battery is contaminated by dirty water, battery acid, dust or other soil, the battery will discharge quickly. Therefore, please follow the following steps to clean the battery:

6.4.1 Turn the power OFF ;

6.4.2 Use a clean cloth to wipe off the soiled part of the wheelchair around the battery.

6.4.3 Clean the terminals and inside of the battery clamps by using a battery cleaning tool, wire brush or medium grade sandpaper. Upon completion, these areas should be shiny, not dull.

6.4.4 Examine the battery clamps/terminals for corrosion, if the terminal is covered by white powder, please stop using the battery due to it indicates that there's possible leakage of the battery. Please replace the batteries.

6.4.5 Carefully dust off all metal particles.

6.5 Replacing the Batteries

Karma strongly recommends that battery replacement and installation always be done by a qualified technician. To replace the batteries, please refer to the photo below of the batteries equipped on Ergo Stand Series, and follow the below instructions to remove and load the batteries.



WARNING





- Do turn off the power of the wheelchair before replacing or loading the batteries.
- Do NOT allow conductive material such as a wrench to contact BOTH battery terminals at the same time. This will result in a short that can cause burns to you and damage the battery.
- Most batteries are not sold with instructions. However, warnings are frequently noted on top of the batteries. Read them carefully.
- Do NOT allow the liquid in the battery to come in contact with skin, clothes or other items. It is a form of acid and may cause harmful or damaging burns. Should the liquid come into contact with skin, rinse the

area immediately and thoroughly with cool water. If liquid comes into contact with eyes, flush eyes immediately and seek medical attention as soon as possible.

- The use of rubber gloves and chemical goggles are recommended when working with batteries.
- NEVER smoke or strike a match near the batteries.
- Replace the batteries IMMEDIATELY if there are any cracks or leaks.

6.5.1 Installation of 36 Ah batteries

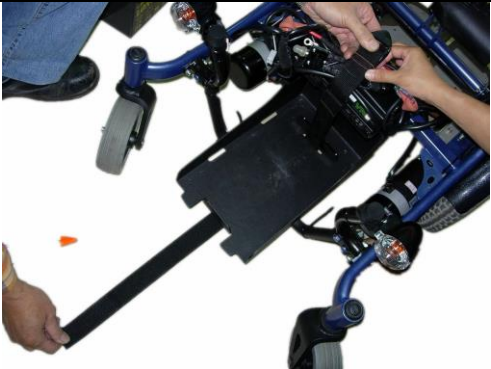
Please follow the instructions below to install 36Ah batteries.

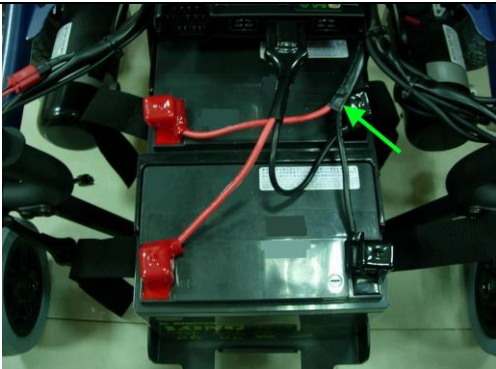
	
1. Tighten the partition plate of the battery.	2. Thread the battery strap through the holes.
	
3. Reserve enough length of the strap.	4. Fasten the batteries with the strap.
	

5. For the power cables, the **RED** cable is connected to the **Positive(+)** terminal of the **rear battery**.
The **BLACK** cable is connected to the **Negative(-)** terminal of the **front battery**.

6. For the circuit breaker cables (the one that the arrow is pointing at), the **RED** cable is connected to the **Positive(+)** terminal of the **front battery**.
The **BLACK** cable is connected to the **Negative(-)** terminal of the **rear battery**.

6.5.2 Replacing 36 Ah batteries

Reverse the above steps to to remove the 36Ah batteries.

6.5.3 Installation of 50 Ah batteries

Please follow the instructions below to install 50Ah batteries.



1.Thread the strap through the holes.



2.Reserve enough length of the strap.



3. Fasten the batteries with the strap.



4. The batteries are now fastened.



5. For the power cables, the **RED** cable is connected to the **Positive(+)** terminal of the **front battery**.
The **BLACK** cable is connected to the **Negative(-)** terminal of the **rear battery**.



6. For the circuit breaker cables (the one that the arrow is pointing at), the **RED** cable is connected to the **Positive(+)** terminal of the **rear battery**.
The **BLACK** cable is connected to the **Negative(-)** terminal of the **front battery**.

6.5.4 Replacing 50 Ah batteries

Reverse the above steps to to remove the 50Ah batteries.

6.5.5 When the batteries are removed, please use the battery strap to fasten the circuit breaker. (Referring to the photo below)



7. INSPECTION AND MAINTENANCE

7.1 Daily Check

Check the following items before driving. If you find anything abnormal, visit your KARMA wheelchair dealer for further inspection before using it.

Item	Inspection Content
Joystick Controller	<ul style="list-style-type: none"> ● Is the joystick loose and/or making noise? ● Can the joystick be turned left and right smoothly ? ● Can the speed buttons be adjusted freely and do they function well ? ● Does the wheelchair stop when the joystick is released completely ? ● Does it light up when the power is ON ? ● Is there enough power for your trip ? ● Does the horn work well ? ● Check if the joystick is bent or damaged ● When the wheelchair power is off, try to push the lever and then release it. Check if it returns to the centre position. If it doesn' t, please immediately contact the dealer.
Motor	<ul style="list-style-type: none"> ● Is there any abnormal motor noise? ● Does the electromagnetic brake work properly ?
Freewheel Mode	<ul style="list-style-type: none"> ● Do the freewheel levers work properly ?
Driver's Seat	<ul style="list-style-type: none"> ● Does the driver's seat recline? ● Do the seat angle adjustment knobs(or buttons)work properly ? ● Does the surface of the seat remain or break ?
Tires	<ul style="list-style-type: none"> ● Are there any cracks or other damage to the tires? ● Check the tire tread depth and air pressure.
Other	<ul style="list-style-type: none"> ● Is there any abnormal noise ?

7.2 Weekly Check

7.2.1 Electromagnetic Brake

This inspection should be performed on a levelled ground. There should be at least one meter wide of empty space free of obstacles.

- Switch the wheelchair on.
- After the chair is switched on for one second, check if the battery gauge is consistently on or blinking slowly.
- Slowly push forward the joystick. When you hear the sound of the electromagnetic brake is activated, the chair is about to move accordingly.
- Release the joystick immediately. Within a few seconds, you can hear the sound from the activation of every electromagnetic brake.
- Repeat the above procedures for three times: slowly pull back the joystick towards the following directions: backward, to the left and to the right.

7.2.2 Connector

Please ensure that all connectors are tightly connected.

7.2.3 Cables

Check if there' s any damage on the cables and connectors.

7.2.4 Joystick Boot

Check if the bottom part of the joystick boot or the cap is damaged or cracked. Examine it only by visual inspection. Do not remove the cap.



CAUTION:

- Visit a KARMA wheelchair dealer for inspection and maintenance if you find anything abnormal.
- Please ensure that all parts of the controlling system are tightened, and do not over-tighten any screw or bolt.

7.3 Regular Maintenance Record

In order to ensure that your wheelchair is in good condition, please contact Karma authorized dealers regularly and make further wheelchair inspection and maintenance records. We recommend that you inspect and maintain your wheelchair **every six months**.

A maintenance/service fee may apply.



WARNING:

- Even if you don't use the wheelchair for a long time, the wheelchair should still be maintained regularly. You should clean your wheelchair, inside and out, regularly to keep it beautiful and safe.

I - Inspection A - Adjustment Δ - Repair
 3 - Replacement T - Tightening L - Add Oil

Item/Period (in Months)		1	6	12	18	24	30
Joystick Control Unit			I	I	I	I/3	I/3
Power Module			I	I	I	I/3	I/3
Controller Buttons			I	I	I	I/3	I/3
Connection to the Electrical System				I		I	I/A
Motor	Operation and Noise		I	I	I/A	I/A	I/3
	Electromagnetic Brakes		I	I	I	I/3	I/3
	Connection to the Electrical System			I		I	
Batteries	Loose or Corroded Terminals			I		I	
	Connection to the Electrical System			I		I	
	Damage to the Electrical Cord/Cable			I		I	
Charger	Charging Function and LED Lights	I	I	I	I/Δ	I/Δ	I/Δ
	Socket, Plug and Cords			I		I	
	Fan Functions Properly			I		I/Δ	

Item/Period (in Months)		1	6	12	18	24	30
Driver's Seat	Recline Levers			I/L		I/L	
Tires	Cracks/Surface Damage	I/3	I/3	I/3	I/3	I/3	I/3
	Tread Depth		I	I/3	I	I/3	I
	Abnormal Wear Pattern			I/3		I/3	
Wheel	Tightness of Bolts and Nuts			T		T	
Rim	Wear or Deformation Around Tires			I/3		I/3	

7.4 Tires

7.4.1 The condition of the tires is affected by the way you drive and use your wheelchair.

7.4.2 Inspecting Tire Tread: please check the tread depth regularly.

7.4.3 Replace the tires when the tread depth is less than 0.5mm.

7.5 General Maintenance

7.5.1 You must maintain the vehicle more frequently if you drive on grass, sand or gravel roads often.

7.5.2 Do not use water, oil or other chemical solutions to clean your wheelchair. Be sure NOT to spray the vehicle with water, as not to damage the electronic components and PCB circuit board. Please clean the vehicle by wiping it with either a dry or moist cloth. Please take the vehicle to an authorized KARMA wheelchair dealer for repairs and adjustments. Improper adjustments could lead to wheelchair malfunction or an accident.

 CAUTION:
<ul style="list-style-type: none"> ● Before performing any maintenance, be sure to turn the power OFF and unplug the charger if connected. ● DO NOT over-tighten hardware. This could cause damage to the frame and hardware.

 **SUGGESTION:**

- Do not directly spray water on your wheelchair to wash it, as this could lead to a malfunction in the electric system.
- Do not use gasoline, solvents or other abrasive solutions; the casing may become deformed or damaged.

 **WARNING:**

- After ANY adjustments, repair or service and BEFORE use, make sure that all hardware is tightened securely, otherwise injury or damage may occur.

7.5.3 Suggested maintenance procedures before you use the power wheelchair: make sure all nuts and bolts are tight. Check all parts for damage or wear and have a qualified technician replace it if necessary. Check all parts for proper adjustment.

7.5.4 Ensure that the batteries are properly maintained and charged as required. Inspect brake for proper operation. The wheels and tires should be checked periodically for cracks and wear, and should be replaced by a qualified technician.

7.5.5 Regularly check for loose nuts and/or bolts in the front and rear wheels. If loose, have them adjusted by a qualified technician. Clean dirt, dust and grease from exposed components. A qualified technician can be found with an authorized distributor/dealer.

7.6 Transporting and Storing

7.6.1 In order to transport easy, the backrest can be folded. Swing out the ring and pull out the lock pin and then the backrest can be folded. (See Figure 7.1) Reverse the order for reassembly, and make sure that the ring is put back its original position. (See Figure 7.2)

7.6.2 Please store the wheelchair in a location where it is out of direct sunlight, rain and dew. When stored for a long time, please charge the batteries to full and then disconnect the battery terminals. For more details, consult your KARMA wheelchair dealer.



(Figure 7.1)

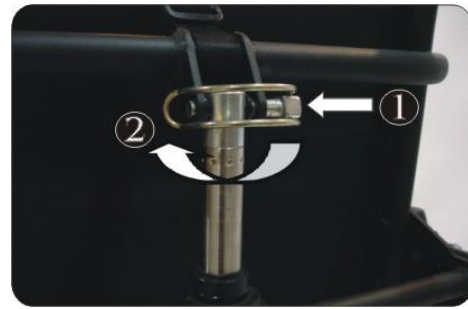

(Figure 7.2)

⚠ WARNING:

- As of this date, Ergo Stand can NOT be used as seats in any vehicles. That is, KARMA recommends that users are NOT transported in any vehicle while seated in the wheelchair. In the case of accident or a sudden stop, the user or passengers may be at risk of getting injury. The suggested solution is to transfer the user from the wheelchair into a vehicle seat and to securely stow the wheelchair in a separate compartment.

7.7 Battery, Circuit Breaker and Tires

7.7.1 Battery : Fully empty of power shall damage the battery and thus reduce the lifetime of the battery. Please charge the batteries when they are in the condition of low power. Please refer to Section 6 for more details about battery.

Battery fixing belt :

Please note there are two fixing belts. You have to connect two belts together to fix the 36Ah batteries into the position; if you use 50Ah batteries, you won't need to connect these two fixing belts but just use them to fasten the batteries separately.

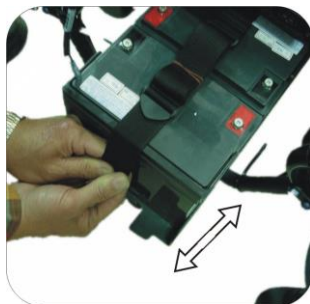

36AH Battery fixing direction.

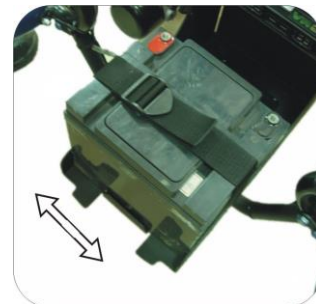

50AH Battery fixing direction.

7.7.2 Circuit breaker : To prevent an over-loading of power from damaging the chair, the circuit breaker will trip to cut the circuit route of the power. If no power supply happened, please also check the circuit breaker.

Note that when the batteries are removed (refer to Sec. 6.7 Replacing the Batteries), please use the battery strap to fasten the circuit breaker.



7.7.3 Tires : You don't need to inflate the tires if you use solid tires. But a regular inspection (once a month) of tire wear is essential. When you find the depth of tire tread is lower than 1mm, or there is any crack on the tires, please contact the service agent to check the tires and replace them if needed. If you use pneumatic tires, please assure the pressure of tire is sufficient for normal driving. In the normal condition, the solid tires and pneumatic tires have the same lifetime.

8. OPTIONAL ACCESSORIES

8.1 H-Shaped Safety Belt. (See Figure 8.1)

8.2 Lighting (Include front/tail light, turning signal)

8.3 Pelvic Seat Belt

8.4 Swing-Away Controller Bracket

8.5 Mudguard

8.6 Hand Brake

8.7 Knee Support

8.8 50AH Battery

8.9 Headrest

8.9.1 Headrest installation Instructions

8.9.1.1 This Karma headrest provides excellent head support.

8.9.1.2 The new design allows compact folding while still attached to the wheelchair.

8.9.1.3 This headrest is designed for wheelchairs with 22 mm rear push handle tubes.

8.9.1.4 Available sizes:

8.9.1.4.1 Large: for wheelchair seat widths between 42 cm-50 cm,

8.9.1.4.2 Medium: for wheelchair seat widths between 36 cm-44 cm, and;

8.9.1.4.3 Small: for wheelchair seat widths between 30 cm-36 cm.

8.9.1.5 Adjustable: back/forth, up/down and the headrest component can rotate 360°.



(Figure 8.1)

Attachments

instructions	1 pc
M5 bolt & nut	2 sets
M5 (5m) wrench	2 pcs
M3 (3m) wrench	1 pc
packng	1 pc

Assembly figure

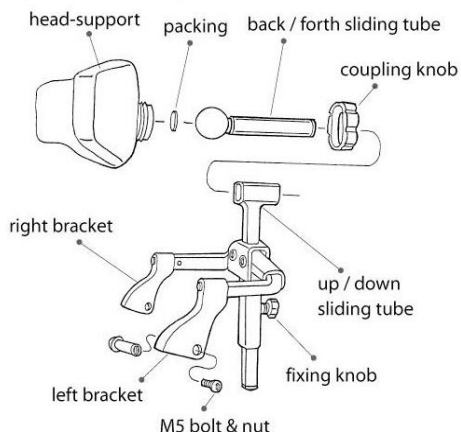

8.9.1.6 This headrest is designed to be used only as indicated in the pamphlet. The manufacturer can't be held liable for any injuries sustained or damage to the wheelchair due to modification made to this device.

8.9.1.7 To avoid injuries or possible damage to the wheelchair, please read the owner's manual carefully before installing this device.

8.9.2 Product Operation

8.9.2.1 How to Install:

Unfold wheelchair. Loosen bolts (A) to allow inner tubes to slide freely. Fit brackets (C) onto the curved part of push handles, then tighten bolts (D).

Have a person help by slightly pushing rear handles of wheelchair apart, simultaneously lift the centre joint (B) as high as possible (in order to obtain adequate support tension for headrest), then tighten bolts (A).



8.9.2.2 How to use:



When using wheelchair, unfold wheelchair first, then prop up the headrest.

Conversely when folding wheelchair, first pull down the headrest to release the support tension, then fold wheelchair.

8.9.3 Maintenance

8.9.3.1 Routine Maintenance:

After using	Monthly	Quarterly
<ul style="list-style-type: none"> - Keep the headrest clean and dry. - Avoid water. - Don't expose it to direct sunlight for extended periods of time. 	<ul style="list-style-type: none"> - Check the rotation mechanism of headrest, don't let it become loose. - Tighten the bolts of the headrest and the wheelchair. 	<ul style="list-style-type: none"> - Check the bolts and tighten. - Apply some lubricant on the bolts.

8.9.3.2 Self-Inspection:

After Using	Monthly	Quarterly
<ul style="list-style-type: none"> - Ensure the headrest unfolds, and the side tubes are folded upward. - The headrest is tightened. - The headrest is clean. 	<ul style="list-style-type: none"> - Mechanism is not loose or cracked. - Check the bolts of the frame for looseness. 	<ul style="list-style-type: none"> - Check the frame for any crack.

8.9.3.3 Troubleshooting:

Situation	Possible Problem	Method
<ul style="list-style-type: none"> - The headrest is unstable. 	<ul style="list-style-type: none"> - The bolts are loose. 	<ul style="list-style-type: none"> - Check the bolts of the frame and tighten them.
<ul style="list-style-type: none"> - The headrest can't be adjusted. 	<ul style="list-style-type: none"> - The bolts are over-tightened. - The inner/outer tubes are dirty. 	<ul style="list-style-type: none"> - Please loosen the bolts a little. - Clean the inner tubes and apply a little lubricant between the inner and outer tubes.

9. TROUBLE SHOOTING

9.1 Trouble or Problems with Your Wheelchair





You can inspect the following before taking your wheelchair to a KARMA wheelchair dealer.









Problem	Checking Points and Corrective Action
My wheelchair does not start	Is the power turned OFF? Turn ON the power.
	Do the batteries still have power? Is the battery indicator light not on? Charge the batteries.
	Is the charger plugged into the wheelchair? Unplug the charger and put it away.

If you cannot solve the problem by yourself, contact your KARMA wheelchair dealer for help.

9.2 VR2 Controller, Battery & Diagnostics Indicator







The following table indicates what the gauge will display for any given state



Indication	Status	Meaning	What to do
	1 signal	The battery needs charging or there is a bad connection to the battery.	Check the connections to the battery. If the connections are good, try charging the battery.
	2 signals	The left hand motor has a bad connection.	Check the connections to the left hand motor.
	3 signals	The left hand motor has a short circuit to a battery connection.	Connect your service agent.
	4 signals	The right hand motor has a bad connection.	Check the connections to the left hand motor.

Indication	Status	Meaning	What to do
	5 signals	The left hand motor has a short circuit to a battery connection.	Connect your service agent.
	6 signals	The wheelchair is being prevented from driving by an external signal.	Please remove the charger.
	7 signals	A joystick fault is indicated.	Make sure that the joystick is in the center position.
	8 signals	A joystick fault is indicated.	Make sure that all connections are secure.
	9 signals	The parking brakes have a bad connection.	Check the parking brake and motor connections and make sure all connections are secure.
	10 signals	An excessive voltage has been applied to the control system.	Check the battery connections.
	7 signals + speed indicator	A communication fault is indicated.	Make sure that joystick cable is securely connected and not damaged.
	8 signals + actuator indicator	An actuator trip is indicated.	If more than one actuator is fitted, check which actuator is not working correctly. Check the actuator wiring.

9.3 LiNX Controller, Battery & Diagnostics Indicator

The following table indicates what the gauge will display for any given state

Flash code		Error description	Possible action
1		Remote joystick error	Check cables and connectors Replace the Remote
2		Network or configuration error	Check cables and connectors Recharge the battery Check charger Replace modules Contact the dealer
3		Left motor error	Check cables and connectors Replace Power Module Check and/or replace left motor
4		Right motor error	Check cables and connectors Replace Power Module Check and/or replace right motor
5		Left park brake error	Check cables and connectors Check left park brake is released Replace modules
6		Right park brake error	Check cables and connectors Check right park brake is released Replace modules
7		Module error (other than Remote)	Check cables and connectors Check modules Replace LiNX Access Key Power Module Recharge battery If the chair stalled, reverse away the chair or remove any obstacles. If the chair was moved while turned off, please wait for a few seconds and switch on the power again.

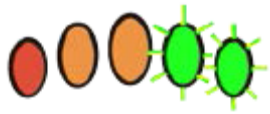
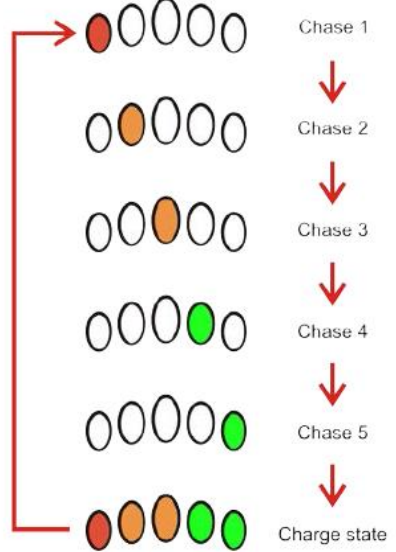
The battery gauge LEDs	Information
 <p>Batt Gauge Maximum</p>	<p>Batt Gauge Maximum is indicated on the battery gauge with all LEDs lit and signifies that the battery level is somewhere between 81 and 100% of full capacity.</p>
 <p>Batt Gauge Low Voltage Warning</p>	<p>A low battery warning is generated when the battery voltage falls below the Batt Gauge Low Voltage Warning set-point. This is indicated on the battery gauge with the red (left-most) LED flashing.</p>
 <p>Batt Gauge High Voltage Warning</p>	<p>A high battery warning is generated when the battery voltage goes above the Batt Gauge High Voltage Warning set-point. This is indicated on the battery gauge with all LEDs lit, and the two green (right-most) LEDs flashing.</p>
 <p>Battery charging</p>	<p>The Battery Gauge will indicate the system is being charged by cycling between a left-to-right chase sequence, and then displaying the approximate battery charge state at the end of the chase sequence.</p>

10. SPECIFICATIONS

Product Model	Ergo Stand (KP-80)		
Nominal seat width (mm)*	400	435	470
Nominal seat depth (mm)**	460	490	520
Front caster / Drive wheel size (in)	6 / 12.5	6 / 12.5	6 / 12.5
Backrest height (mm)	455	455	455
Headrest height above seat (mm)	N/A	N/A	N/A
Armrest to seat distance (mm)	170 ~ 250	170 ~ 250	170 ~ 250
Front location of armrest structure (mm)	390 ~ 560	390 ~ 560	390 ~ 560
Seat surface height at front edge (mm)	495	495	495
Footrest to seat distance (mm)	380 ~ 440	380 ~ 440	380 ~ 440
Effective seat width (mm)	420	455	490
Effective seat depth (mm)	500	530	560
Seat plane angle (X°)	5	5	5
Backrest angle (X°)	(-10) ~ 30	(-10) ~ 30	(-10) ~ 30
Seat to backrest angle (X°)	75 ~ 115	75 ~ 115	75 ~ 115
Leg to seat angle (X°)	92	94	96
Overall length with legrest (mm)	1000 ~ 1120	1005 ~ 1165	1005 ~ 1205
Overall width (mm)	640	640	640
Overall height (mm)	920 ~ 995	920 ~ 995	920 ~ 995
Folded length (mm)	965	965	965
Folded width (mm)	640	640	640
Folded height (mm)	760	760	760
Total mass (kg)	92.0	92.0	92.0
Total mass without batteries (kg)	60.6	60.6	60.6
Mass of the heaviest part (kg)	46.5	46.5	46.5
Maximum user weight (kg)	135	135	135
Motor power (W)	300	300	300
Battery capacity (Ah)	50*2	50*2	50*2
Charger output current (A)	6	6	6

Drive range (km)***	25.9	25.9	25.9
Battery Compartment (L x W x H) (mm)	330 x 200 x 185	330 x 200 x 185	330 x 200 x 185
Maximum speed forward (km)	9.3	9.3	9.3
Minimum braking distance from max speed (mm)	1800	1800	1800
Obstacle climbing (mm)	60	60	60
Ground clearance (mm)	60	60	60
Minimum turning radius (mm)	745	745	745
Minimum turning radius without user (mm)	745	745	745
Reversing width (mm)	1230	1230	1230
Static stability downhill (X°)	16.7	16.7	16.7
Static stability uphill (X°)	20	20	20
Static stability sideways (X°)	16	16	16
Dynamic stability uphill (X°)	6	6	6
Ability to climb rated slope (X°)***	12	12	12

* **Nominal seat width** is measured the width of seat cushion at 120mm in front of the backrest. This value is mainly used in the product ordering process.

** **Nominal seat depth** is measured from the front end of the seat cushion to the back cushion. This value is mainly used in the product ordering process.

*** **Drive range/ Ability to climb rated slope** are estimated based on the following conditions: 20°C~35°C, 135 kg occupant, brand new fully charged batteries and driving on the flat road.

- The actual product specifications differ from the data in the table by ± 1 cm ± 0.5 kg.
- The actual product specifications may vary according to different configurations.
- Karma reserves the right to modify information herein without further notice.
- If you want to know more about the measurement methods of wheelchair specifications, please scan the QR code to watch the instructions on the Karma website.



11. CLEANING & RECYCLING

11.1 Cleaning

11.1.1 In order to lengthen the life of your wheelchair, it is suggested that you clean the wheelchair periodically (if not daily), especially after it is used in the rain or snow. We suggest that you don't use your wheelchair in the rain or snow. If you are travelling and get caught in the rain, we suggest you try to find shelter and turn OFF your wheelchair while waiting it out. If you can't find shelter, proceed to your destination. However we do not recommend you do this often as it may shorten the life of your wheelchair or cause damage.

11.1.2 Driver's seat upholstery: use soapy water. Wring out the sponge/cloth before scrubbing. Do not use the wheelchair until it is dry.

11.1.3 Frame: wipe with a damp cloth, but be sure not to splash/spray the wheelchair with water, as doing so may damage the motor, electrical wiring and battery. If compressed air is available, you can use the compressed air to clean your wheelchair (do not exceed 7kg/cm² and keep the nozzle at least 10 cm away from your wheelchair).

11.1.4 Casing: wipe with a damp cloth. After it is dry, coat the casing with a light layer of wax, if desired.

11.2 Post-Consumer Recycling

11.2.1 A post-consumer recycling plan should follow the Environmental Protection Administration's regulations. The items listed below are for reference only as local law and regulation may vary.

Material	Part Name	Method
Aluminum-alloy	Frame	Recyclable
ABS	Various	Recyclable
Various	Battery	Recyclable
Various	Motor/Reduction Gear	Recyclable
Various	Electric Parts	Recyclable

11.2.2 There are many organizations in many countries you can find on the internet that will accept used goods for charity or disassemble electronic equipment and batteries to recycle them. Please search the Internet to help less fortunate individuals and protect our planet for future generations. If you do not have access to the world wide web please use your local phone directory, ask for operator assistance or go to your local government center for more information. Various parts of this wheelchair should be recycled to the collection and recycling location nearest to you. Earth Day is every day.

11.2.3 Check with your local recycling centre on where and how to recycle used batteries as this information varies from region to region.



12. WARRANTY

12.1 Serial Number

To ensure after-sale service and warranty, please record and fill in the serial number which can be found on the steering column below the control panel.

This warranty is VOID if the original chair serial number is removed or altered.

Model	Ergo Stand (KP-80)
Serial Number	

12.2 Contents and Duration of Warranty

12.2.1 If the parts of the product need to be repaired or replaced due to manufacturing defects, they can be repaired or replaced free of charge within the warranty period (a repair of this kind will hereafter be called warranty maintenance).

12.2.2 Frame is warranted for a period of 5 years and electrical system (controller, motor, charger, actuator and PCB) for a period of 1 year after delivery to the customer, then the affected parts will be repaired or replaced free of charge.

12.2.3 Battery warranty is subject to the periods set by the manufacturers. Please contact your local dealer in detail.

12.2.4 Consumable parts such as bearings, cables, carbon brushes, circuit breakers, covers, footplates, light bulbs, pads, side guards, upholsteries, wheels and similar parts are excluded from the warranty.

12.2.5 Warranty maintenance can be performed by authorized KARMA wheelchair dealers only.

12.2.6 KARMA is not responsible for the transportation costs for repair and replacement.

12.2.7 Warranty maintenance is the repair or replacement according to the condition of the parts, and replaced parts will be the property of KARMA.

12.2.8 KARMA reserves the right to modify product specifications without further notice; KARMA is not responsible for any changes to product specifications.

12.3 The Claims from This Warranty Shall Not Arise for The Following Reasons

12.3.1 The product or part has been damaged by accident, improper use, incorrect assembly or poor maintenance. The evaluation of it is the privilege of KARMA.

12.3.2 Damage resulting from normal wear and tear.

12.3.3 Any overloading of the product, please check the label for maximum user weight.

12.3.4 The product or part has not been maintained or serviced in accordance with the manufacturer's recommendations as shown in the User Manuals and/or the Service Manuals.

12.3.5 Use or install parts or accessories which are not manufactured or not approved by KARMA.

12.3.6 Damage resulting from use in unsuitable environments.

12.3.7 Damage resulting from any addition, modification, or alteration of the product or parts without the approval by KARMA.

12.3.8 Damage resulting from external factors, such as chemicals, oil, debris, etc.

12.3.9 Damage caused by natural disasters.

12.4 The Responsibilities of the User

12.4.1 Fully adhere to operation guidelines set forth in this manual.

12.4.2 Perform self-inspection and basic maintenance.

12.4.3 Keep a record of self-inspections and basic maintenance.

12.4.4 Not permit any alteration, addition, or modification or use of parts not manufactured by KARMA.

12.4.5 Thoroughly read and understand this manual.

12.5 The Responsibilities of the Dealer

12.5.1 Follow this owner's manual and educate user about product operation and basic maintenance.

12.5.2 Verify and check whether the warranty conditions are met.

12.5.3 Provide relevant warranty information and recommendations for improvements.

12.6 Transfer of Warranty Rights

If you purchase a second-hand KARMA wheelchair while it is still within the warranty period, bring this user manual and the wheelchair to the authorized dealer and perform necessary product inspection, maintenance and warranty inheritance procedure.

Full Name:	
Gender:	
Date of Birth:	
Address:	
Model:	KARMA Ergo Stand (KP-80)
Serial Number:	
Date of Purchase:	
Purchaser Signature:	

Dealer's Data

Name of the Store:	
Phone No. and Address:	

If you have any suggestions on how to improve our products, please don't hesitate contacting your local dealer to let us know what you think of your wheelchair. Thank you and enjoy.

karma

A Better Wheelchair, A Better Fit



KARMA MOBILITY S.L European Support Center.
www.karmamobility.es
+34 984 390 907
karma@karmamobility.es

KARMA MOBILITY LTD. UK representative
www.karmamobility.co.uk
+44 845 630 3436
info@karmamobility.co.uk

KARMA MEDICAL PRODUCTS CO., LTD.
www.KarmaMedical.com
+886 5 206 6688
globalsales@karmam.com.tw