

390100000054 & 110707090009
390100000055 & 110707090009

karma
A Better Wheelchair, A Better Fit

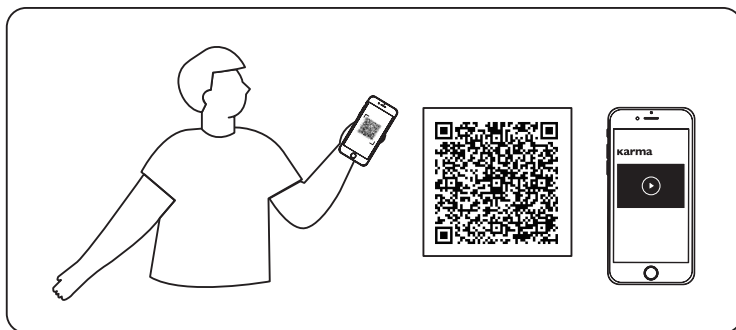

1X
390100000055 &
110707090009

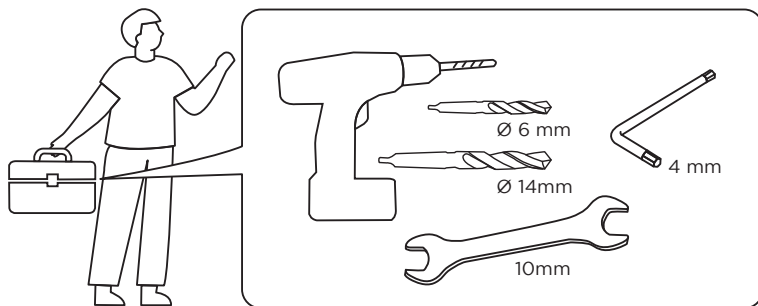
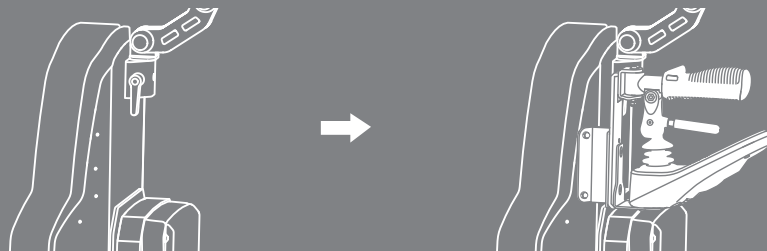
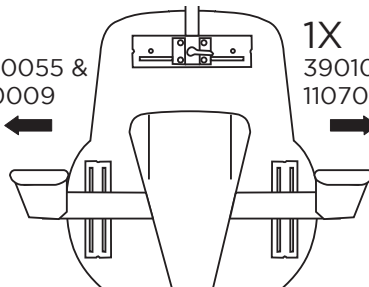

1X
390100000054 &
110707090009

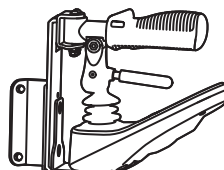

1

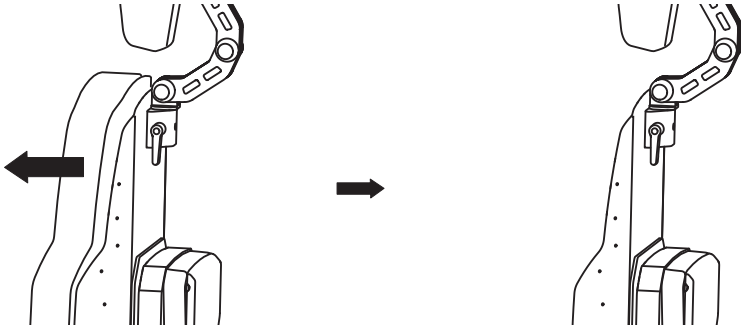

2

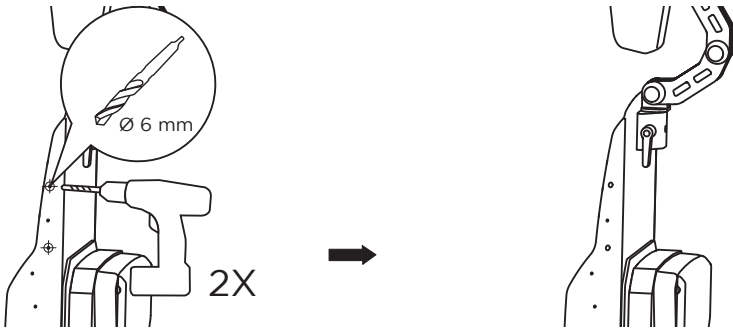

3

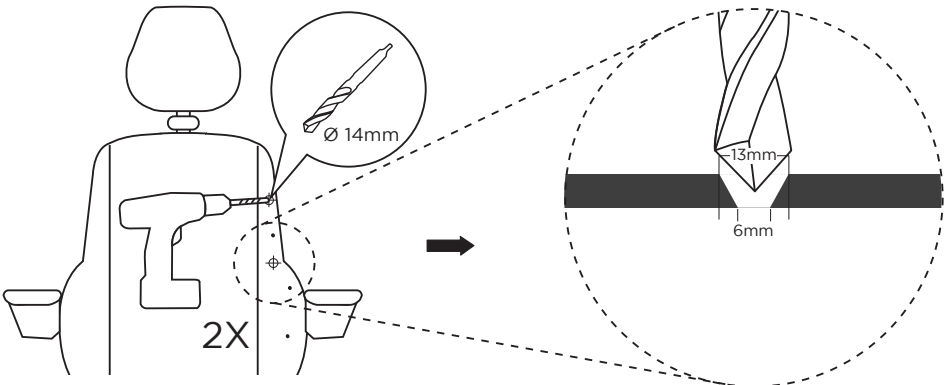

4

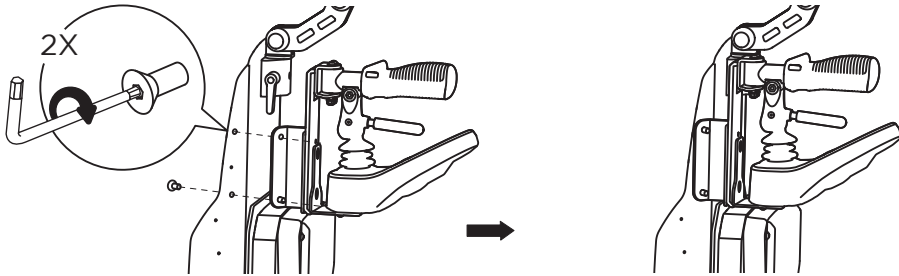

5

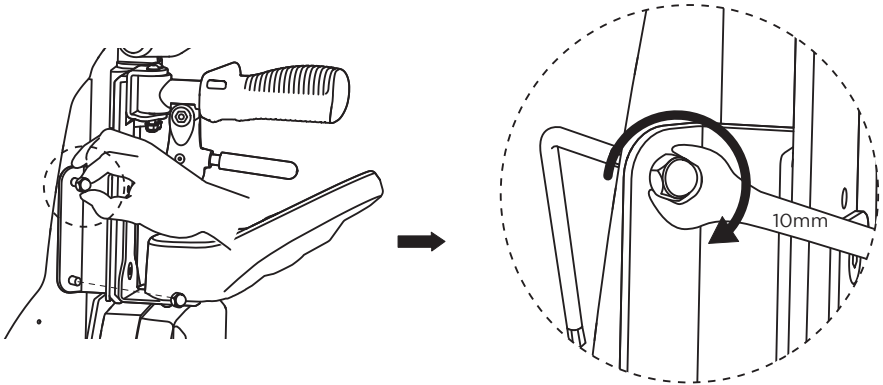

6

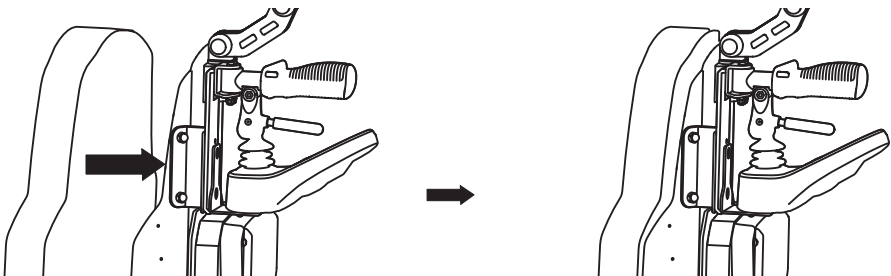

Do not change the programmed driving characteristics of your control unit, as it is specific for the situation of the user. If any adjustment is required because of a change of circumstances, please contact your supplier.