

karma

User manual

VIP 515 Series

(KM-1520.3T)



CE UK
CA

A Better Wheelchair, A Better Fit

GENERAL WARNING

- For individuals with balance problems, practice mounting and dismounting activities WITH AN ASSISTANT in the presence of a qualified healthcare professional.
- If anti-tippers are standard equipment, DO NOT operate the wheelchair without anti-tippers being installed. Anti-tippers MUST BE attached at all times.
- DO maintain your chair well, in particular check the tire pressure since this affects the efficiency of the brakes.
- DO make sure that both brakes are applied before getting in or out of the chair.
- DO make sure that both brakes are applied when the chair is not being pushed or used.
- DO take care when climbing kerbs or turning on slopes.
- DO avoid steep or uneven surfaces that may cause the chair to tip over.
- DO avoid soft surfaces because the casters may become bogged down.
- DO travel smoothly in all conditions.
- DO look well ahead to anticipate hazards such as furniture, doors, potholes, etc.
- DO make sure that both of the user's feet are safely on the footrests and that clothing is safely tucked out of the way so that it cannot get caught in the wheels.
- DO take care when traveling up or down or across inclines.
- DO keep both hands on the push handles to control the chair, if you are the attendant.
- DO pay attention to keep the chair balanced.
- DO check the frame and components regularly and refer to this owner's guide during and after the warranty period.
- DO tie-up the upholstery or replace it with a new one when it becomes loose.
- DO lubricate the bearings regularly.
- DO equip with anti-tippers to avoid tipping backwards.

- DO equip with a seat belt designed for disabled people.
- DO equip with "ankle supports" for disabled people.
- DO clean both hands after oiling the wheelchair.
- DO tighten the screws of headrest tubes.
- DO NOT overload the chair in any circumstance.
- DO NOT hang anything heavy on the back of the chair that could cause the chair to become unstable, particularly when negotiating inclines.
- DO NOT allow more than one user at a time.
- DO NOT have any unconscious patient use the wheelchair.
- DO NOT use other transport to pull the wheelchair.
- DO NOT do "wheelies", as you may fall or tip over backwards and suffer a severe injury.
- DO NOT sit in a wheelchair within a moving vehicle unless it has been affixed the labels of hook mark.
- DO NOT go too fast or turn too quickly.
- DO NOT stand on the footplates when getting in or out of the chair.
- DO NOT go down steps forward, whether solo or with an attendant.
- DO NOT attempt to lift the wheelchair by any removable (detachable) parts. Lifting by means of any removable (detachable) parts of the wheelchair may result in injury to the user and/or assistant or damage to the wheelchair.
- DO NOT use the wheelchair when the back is folded. This alters the centre of gravity and may cause the wheelchair to tip backwards. The back should only be folded for storage or transport of the wheelchair.
- DO NOT hang anything on the back joint that could cause the backrest folding suddenly and may cause injury.

YOU AND YOUR KARMA SERVICE PROVIDER

- No tools are required for assembly. Your wheelchair should be assembled by your authorized KARMA dealer. Your authorized KARMA dealer is also your service provider. Unauthorized repairs, upgrades and add-ons will void your warranty. Anything wheelchair related that requires tools should be done by your authorized KARMA service provider. Your KARMA service provider has the necessary service/maintenance owner's manual for your wheelchair.
- If you have any defective parts or lose any parts, please contact your dealer for repair and/or replacement. Please only use parts authorized by KARMA. Use of parts that are not authorized by KARMA will void your warranty.
- Part numbers are listed on our bill of materials (explosion drawings), which we give to our authorized dealers and service providers. Customers should order parts through their dealer as well as all repairs and scheduled maintenance.
- Customers should go to their dealership for all service needs to guarantee their warranty is not void. Always go to an authorized service provider. Unauthorized repairs will void your warranty. Procedures other than those described in this owner's manual must be performed by a qualified technician. They also have the service owner's manual with a complete list of maintenance required to keep your KARMA wheelchair in top performance. Check the warranty section of this owner's manual to find out what KARMA guarantees and what maintenance and parts you will have to pay for.
- KARMA does not have an official list of service providers at this time. Please contact your dealer for service. If you cannot contact your dealer, please contact another authorized KARMA dealer for service. If all else fails, contact KARMA directly via our website or give us a call and we can refer you to your new service provider.

CE MARKING

- This wheelchair complies with the requirements of the Medical Devices Directive 93/42/EEC.



CAUTION:

- Before purchasing and using KARMA wheelchairs, please consult qualified professionals so as to ensure that you choose suitable products and use them correctly as well. For safety reasons, if there is any risk due to the user's movement in the wheelchair or other environmental factors that might cause the wheelchair to tip or the person on the wheelchair to fall off, KARMA recommends that you install anti-tippers, pelvic belt, safety belt, or other additional safety accessories.

TABLE OF CONTENTS

1. PREFACE	1
2. SAFETY	1
2.1 Doorways	1
2.2 Leaning	2
2.3 Negotiating Inclines.....	2
2.4 Kerbs	2
2.5 Stairs	2
2.6 Streets.....	3
2.7 General.....	3
2.8 Upholstery	3
2.9 Anti-tippers	4
2.10 Maximum User Weight Limit	4
2.11 Avoid General Misuse	4
2.12 Labeling.....	5
3. INTENDED USE & PARTS	6
3.1 Intended Use	6
3.2 VIP 515 Parts Description.....	7
4. OPERATION	8
4.1 Preparing For Use	8
4.2 Folding.....	9
4.3 Adjustments.....	10
4.4 Headrest.....	11
4.5 Back Upholstery.....	11
4.6 Tilting Your Wheelchair.....	11
4.7 Flip-back armrest	12
4.8 Armrest Height adjustment	12
4.9 Transporting and Storing	13
4.10 Transferring In and Out	13
4.11 General Use.....	14
4.12 Tilting by the Attendant.....	16
4.13 Tilting by the User	16

4.14 Going Down Kerbs	17
4.15 Going Up Kerb	18
4.16 Up and Down Steps/Stairs	18
4.17 Transportation	19
4.18 Before use.....	20
4.19 Method of restraint.....	21
4.20 Fitting seat BeLt.....	22
4.21 Safety Belt.....	22
4.22 How to operate it.....	24
5. INSPECTION AND MAINTENANCE.....	25
5.1 Daily Check.....	25
5.2 Regular Maintenance Record	25
6. OPTIONS AND ACCESSARIES	28
7. TROUBLESHOOTING.....	29
8. SPECIFICATIONS	30
9. CLEANING & RECYCLING.....	32
9.1 CLEANING.....	32
9.2 Frame.....	32
9.3 Upholstery.....	32
9.4 POST-CONSUMER RECYCLING	32
10. WARRANTY	33
10.1 Serial Number.....	33
10.2 Warranty Policy.....	33

1. PREFACE



Please carefully read this owner's manual before using the wheelchair.

Improper use of the wheelchair could result in harm or injury. Therefore, for safe and enjoyable use of the wheelchair, please read this owner's manual.

1.1 This owner's manual includes operation instructions for the aspects of the wheelchair, unfolding/folding instructions, and instructions on how to deal with possible accidents.

1.2 This owner's manual is written for KARMA wheelchair: VIP 515 Series.

1.3 The symbols used in this owner's manual are explained below. Pay special attention to the parts marked with these symbols.

 WARNING:	Improper use could lead the user to severe injury or death.
 CAUTION:	Improper use could lead the user to severe injury and/or damage to your wheelchair.
 SUGGESTION:	Follow these instructions to keep the wheelchair in good condition.

1.4 This owner's manual includes the repair and maintenance chart as well as the warranty.

1.5 If someone else uses the wheelchair, make sure that you give him or her this owner's manual for his or her reference.

1.6 As designs change, some illustrations and pictures in this owner's manual may not correspond to the wheelchair that you purchased. We reserve the right to make design modifications without further notice.

2. SAFETY

2.1 Doorways

The safest way to operate the chair is on level floors that are free of obstacles.

Whenever possible use a ramp to enter or exit a facility. Keeping your hands on the push rims will allow you to maintain maximum balance. Do not try to force yourself over an obstruction by propulsion and never use the sides of a doorway to pull yourself through a passageway.

2.2 Leaning

Do not lean over the side of your wheelchair since such an action may cause you to lose balance and fall. (See Figure 2.1)

2.3 Negotiating Inclines

2.3.1 Never turn on a hill due to the danger of tipping.

2.3.2 When an attendant is pushing the wheelchair straight up a slope, if the user needs to go down midway, walk backwards until the user is on level ground. (See Figures 2.2 and 2.3)

2.3.3 Avoid stopping on an incline; it can potentially cause you to lose control of the chair.

2.3.4 Do not use the brakes to slow down or stop the wheelchair, this could cause it to seize up and make the user to lose control or fall out of the wheelchair.

2.3.5 Whenever possible, utilize help from an assistant/attendant while negotiating inclines.

2.4 Kerbs

2.4.1 Whenever possible get help from an assistant/attendant (if you have assistance make sure that your chair is equipped with push handles).

2.4.2 Avoid hard impacts when descending a kerb. A hard impact could adversely affect the chair.

2.4.3 Never try to scale or descend kerbs that exceed a normal height.
(30-50cm)

2.4.4 Always be careful when climbing kerbs and never move up or down a kerb in reverse without an assistant.

2.5 Stairs

2.5.1 Always use two or more assistants.

2.5.2 Never go down steps forwards.

2.5.3 Never use an escalator for transport, use an elevator.

2.6 Streets

2.6.1 Always use extreme caution when crossing streets. Reflective tape on the chair and/or your clothing will make you more visible to drivers.

2.6.2 Avoid potholes and rough terrain that might cause the casters to become stuck. (See Figure 2.4)

2.7 General

2.7.1 The expected service life of the product is **five years**, presuming that the product is used daily in accordance with the safety operation instructions, inspection and maintenance instructions, and intended use, which described in this manual.

2.7.2 Always make sure BOTH brakes are applied before getting in or out of the chair.

2.7.3 Never stand on the footplates when getting in or out of the chair.

2.7.4 Never carry more than one passenger. KARMA wheelchairs are limited to one user.

2.7.5 Use caution to assure your clothing doesn't get tangled with the wheels.

2.7.6 When the user is operating the wheelchair using the pushrim, please push the wheelchair gently. DO NOT apply a sudden huge force on the pushrim. It could cause the chair to tip over. Please refer to the figure below for the best grip points for using the pushrim.



2.8 Upholstery

2.8.1 When cleaning the upholstery, use warm water and a mild soap.

2.8.2 Upholstery cleaner/foam can also be used, but avoid other cleaning solvents.

2.9 Anti-Tippers

2.9.1 Please purchase anti-tippers and always use them to avoid personal injury.

CAUTION:

- When tilting your wheelchair, please change to position No.3 to avoid tipping and causing injury to the user. (See the bellow figures)



2.10 Maximum User Weight Limit

2.10.1 Refer to "Max. User Weight" in Section 8. SPECIFICATIONS.

2.10.2 Loading exceeding maximum capacity can damage your wheelchair and cause malfunctions yielding a safety hazard.

2.10.3 The warranty does not cover damage caused by improper operation of the wheelchair.

2.11 Avoid General Misuse

2.11.1 Please note that our "Owner's Manual" contains a number of cautions -- any vehicle can cause injury if misused -- use within our guidelines and with reasonable care and your safety will be increased.

2.11.2 Your wheelchair will give years of safe use if used sensibly and carefully.

2.11.3 Be aware that careless use endangers your own safety as well as that of others. ALWAYS follow the Highway Code when outdoors and the guidelines written in this owner's manual.

2.11.4 Do not let children stand or play on the wheelchair. (See Figure 2.5)



Figure 2.1



Figure 2.2



Figure 2.3



Figure 2.4



Figure 2.5

2.12 Labeling

Please carefully read all the labeling on the wheelchair before driving it. Do not remove them. Protect them for future reference.

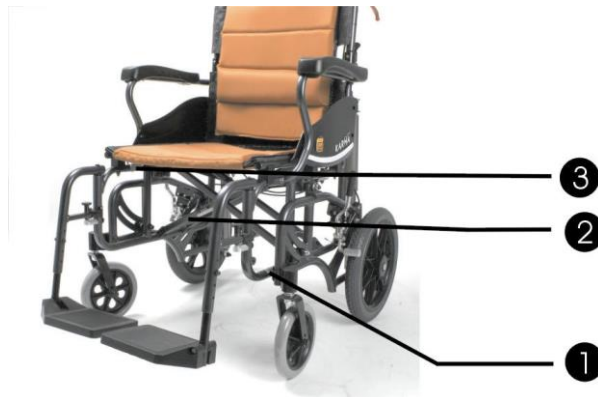

1

EC	REP	KARMA MOBILITY, S. L. C/ PERIODISTA FRANCISCO CARANTOÑA DUBERT, 23 Bajo 33209 GUÓN - ASTURIAS (SPAIN)	CE
UK	REP	KARMA MOBILITY LTD. UNIT 6 TARGET PARK, SHAWBANK ROAD, REDDITCH, B98 8YN ENGLAND UNITED KINGDOM	UK CA
		KARMA MEDICAL PRODUCTS CO., LTD. NO. 2365, SEC. 2, UNIVERSITY RD., MIN-HSIUNG SHIANG, CHIA-YI HSIEN, TAIWAN R.O.C.	MD
<p>WARNING! USE ONLY ON STABLE SURFACES MAXIMUM USER WEIGHT 115kg (255 lbs)</p>			

3

2

karma SERIAL NO. M12-1234

Model:	
Order No.:	
Delivery Date:	
Sewing No.: 1 <input type="checkbox"/> 2 <input type="checkbox"/> 3 <input type="checkbox"/> 4 <input type="checkbox"/> 5 <input type="checkbox"/> 6 <input type="checkbox"/>	
Seat Width	Seat Depth
<input type="checkbox"/> 13	<input type="checkbox"/> 13
<input type="checkbox"/> 14	<input type="checkbox"/> 14
<input type="checkbox"/> 15	<input type="checkbox"/> 15
<input type="checkbox"/> 16	<input type="checkbox"/> 16
<input type="checkbox"/> 17 - <input type="checkbox"/> 0	<input type="checkbox"/> 17 - <input type="checkbox"/> 0
<input type="checkbox"/> 18 - <input type="checkbox"/> 5	<input type="checkbox"/> 18 - <input type="checkbox"/> 5
<input type="checkbox"/> 19	<input type="checkbox"/> 19
<input type="checkbox"/> 20	<input type="checkbox"/> 20
<input type="checkbox"/> 21	<input type="checkbox"/> 21
<input type="checkbox"/> 22	<input type="checkbox"/> _____
<input type="checkbox"/> _____	<input type="checkbox"/> _____
karma	Unit: inch

3. INTENDED USE & PARTS

3.1 Intended Use

- 3.1.1 The VIP 515 series is a self-propelled or transit wheelchair. That is, it can either be propelled by an attendant (transit) or by the user(self-propelled).
- 3.1.2 These wheelchairs are suitable for users up to 115kg in weight. Hand brakes are provided for both rear wheels and are connected to a dual attendant brake located on the left push handle.
- 3.1.3 It has an extremely durable aluminum alloy frame with tough accessories and does not suffer in dramatic extremes of temperature (neither user nor attendant need touch metal parts in normal use).
- 3.1.4 This chair is designed for both indoor and outdoor use.
- 3.1.5 The casters have solid tires for greater durability; pneumatic casters are available on request.
- 3.1.6 Rear wheels are 20 inches in diameter and solid PU tires are available on request.
- 3.1.7 When prescribing wheelchairs for use by full or partial amputees (above or below knee, single or double) or other conditions that affects the user's natural center of gravity, we suggest contacting your therapist or dealer as well as attaching anti-tippers.
- 3.1.8 Intelligent 0 ° -35° center-of-gravity weight-shifting tilt-in-space seat shifts pressure to reduce bedsores, while providing wheelchair users a wide choice of tilt-in-space angles with increased balance and stability.
- 3.1.9 Lightweight foldable design allows easy transport.
- 3.1.10 The gas cylinders make attendant to tilt user more easily.

3.2 VIP 515 Parts Description

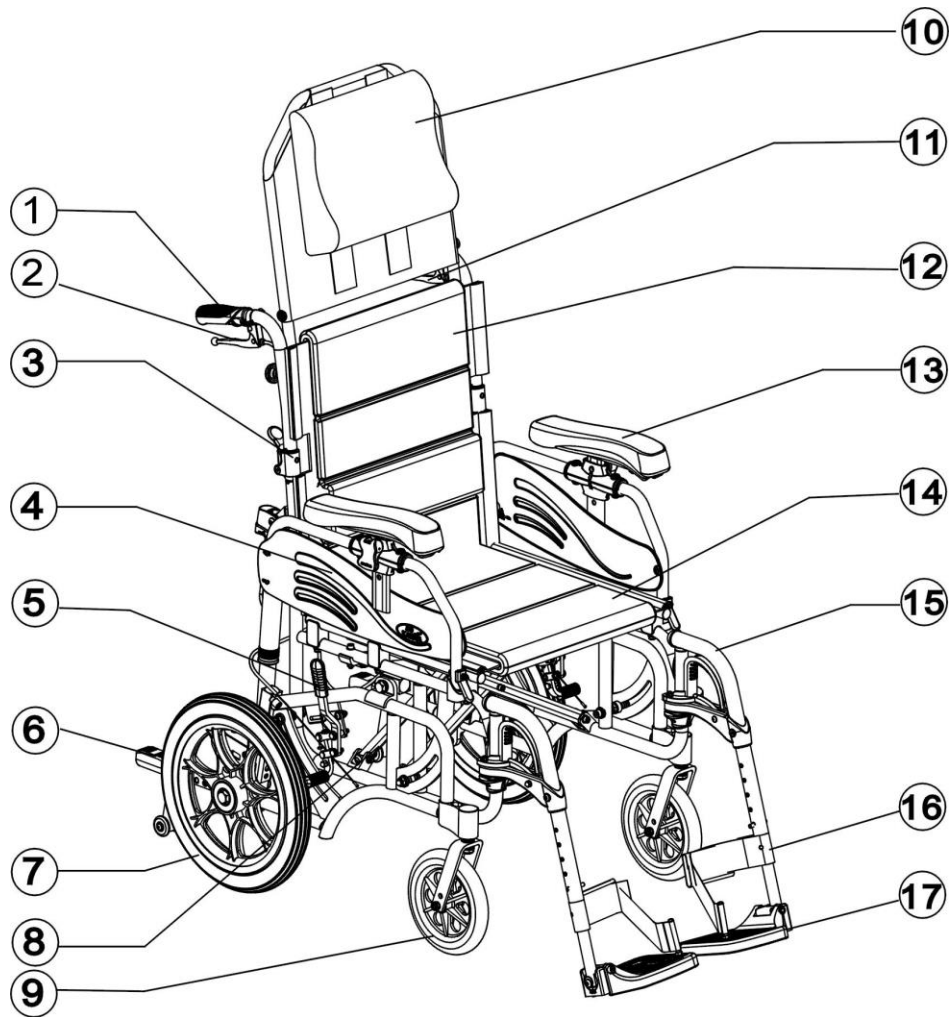

1. Push Handle

2. Tilt Lever

3. Back Joint

4. Side Panel

5. Brake

6. Anti-Tippers

7. Rear Wheel

8. Cross Brace (Cross Bar)

9. Caster

10. Headrest Upholstery

11. Attendant Brake

12. Back Upholstery

13. Flip-back Height Adjustable
Armrest

14. Seat Upholstery

15. Footrest

16. Heel Loop

17. Footplate

4. OPERATION

4.1 Preparing For Use

4.1.1 Unfolding

4.1.1.1 Holding the armrests, pull outwards. (See Figure 4.1)

4.1.1.2 Pointing your fingers inward with the palm of your hand on the frame, push down until the seat is fully lowered. Make sure the frame is firmly seated in its holder. (See Figure 4.2)

4.1.1.3 Holding the swing-away footrest, lower it into its coupling at 45° from the side. Swing the footrest towards the middle until you hear it click into place. (See Figure 4.3)

4.1.1.4 Flip the footplates down. (See Figure 4.4)

4.1.1.5 Attach the headrest and tighten the knob bolts. (See Figure 4.5)

4.1.1.6 Ready for action!

CAUTION:

- Please be sure to tighten the knob bolts of the headrest or else it might result in injury to the user or damage to the wheelchair.

Alternatively, you can stand at the side of the chair and complete step 1 by pulling the nearest armrest towards you and pushing the other one away.



Figure 4.1



Figure 4.2

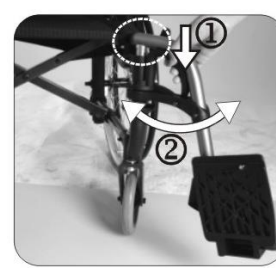

Figure 4.3



Figure 4.4



Figure 4.5



CAUTION:

- Be careful not to get your fingers caught when folding the wheelchair.
- When completing step 2 never put your fingers around the sides or under the chair as they can be trapped between the seat and the frame. (See Figure 4.6)

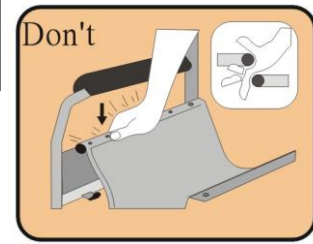

Figure 4.6

4.2 Folding

4.2.1 Remove the headrest. (See Figure 4.7)

4.2.2 Flip up the footplates. (See Figure 4.8)

4.2.3 Squeeze the swing-away footrest release handle and rotate the footrest to either side for removing. (See Figure 4.9)

4.2.4 Pull up on the seat upholstery by holding it in the center of its front and back edge. (See Figure 4.10)

4.2.5 Press the two release levers on the backrest frame (push handle tubes) to fold the backrest down for compact storage and easy transport. (See Figure 4.11)

4.2.6 Folding is now completed.



Figure 4.7



Figure 4.8



Figure 4.9



Figure 4.10



Figure 4.11

4.3 Adjustments

4.3.1 Footrest

4.3.1.1 Footrests can rotate in or out, which makes transferring in limited spaces easier. Swinging both footrests inward makes it easier to work at a desk. (See Figures 4.12 and 4.13)

4.3.1.2 To adjust the footplate height, use the KARMA tool provided to loosen the bolt at the side of the footrest arm.

4.3.1.3 Adjust it to the desired height, re-tighten the bolts and make sure the footplate is firm. Then tighten the nut as a locknut from outside. (See Figure 4.14)

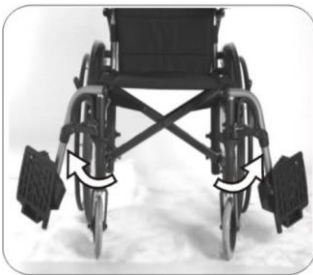

Figure 4.12



Figure 4.13



Figure 4.14



Figure 4.15

SUGGESTION:

- Make sure that the footplate height is adjusted properly according to the user's calf length to reduce pressure on the body.
- The footrest height must be more than 5cm to the ground. (See Figure 4.15)

4.3.2 Footrest

4.3.2.1 Squeeze the swing-away footrest release handle and rotate the footrest to either side for removing. (See Figure 4.16)



Figure 4.16

4.4 Headrest

Your headrest height may be adjusted to a suitable position for you. Simply attach or detach the headrest using the hook and loop fabric. (See Figure 4.17)



Figure 4.17

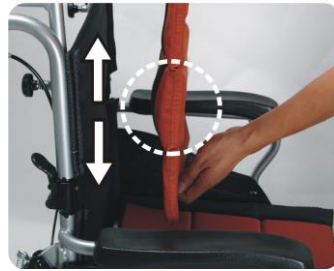

Figure 4.18

SUGGESTION:

- Before using the chair, please attach the headrest and tighten the screws.

4.5 Back Upholstery

There is a thicker part in the middle of backrest upholstery. It is designed to support the user's lower back. Please adjust it to fit you and attach it on the backrest using the hook and loop fabric. (See Figure 4.18)

4.6 Tilting Your Wheelchair

4.6.1 Please lock both brakes. (See Figure 4.19)

4.6.2 Grasp the right push handle and squeeze the tilt lever. (See Figure 4.20)

4.6.3 Press downward with both hands simultaneously until the desired seat angle is achieved and then release the lever. (See Figure 4.21)



Figure 4.19



Figure 4.20



Figure 4.21

4.7 Flip-Back Armrest

4.7.1 Armrest flips back by pressing the release lever located at the front base of the armrest.

4.7.2 After you press the release lever, you can lift and rotate the armrest backwards. (See Figures 4.22 and 4.23)

4.7.3 The height adjustment : Simply loosen and remove the knob bolt, then adjust the armrest to the desired height and finally reattach the knob bolt.

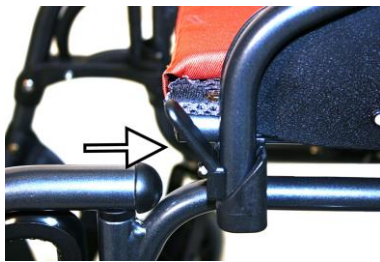

Figure 4.22



Figure 4.23

4.8 Armrest Height Adjustment

4.8.1 You may adjust the armrest height by below steps. (See Figure 4.24) .

4.8.2 Pull the knob into horizontal position to release the armrest.

(See Figure 4.25) .

4.8.3 Adjust the armrest to the desired position and retighten the knob by push down the knob into vertical position to fix the armrest. (See Figure 4.26) .



Figure 4.24



Figure 4.25



Figure 4.26

4.9 Transporting and Storing

Make sure the wheelchair is folded when stored.

SUGGESTION:

- Please store the wheelchair in a location where it is out of direct sunlight, rain and dew. For more details, consult your KARMA dealer.

WARNING:

- Don't put anything on the wheelchair while it is in storage. Storing goods on a folded wheelchair will cause damage and is not covered under warranty. (See Figure 4.27)



Figure 4.27

4.10 Transferring In and Out

4.10.1 Transferring In

4.10.1.1 Engage both hand brakes.

4.10.1.2 Turn the footplates up and swing them to the side.

4.10.1.3 The user lowers himself/ herself into the seat using the armrests for support.

4.10.1.4 Turn the footplates back down, so that the user can place his feet on them.

4.10.1.5 Release both hand brakes.

CAUTION:

- Always ensure that the front casters are in line with the rear wheels and pointing forwards and that the back of the chair is secure either against a wall or firmly held by an attendant.

4.10.2 Transferring Out

4.10.2.1 Make sure that the chair is near your destination.

4.10.2.2 Back the chair sufficiently to ensure that the casters are pointing forward, i.e. in line with the rear wheels and usually with the caster forks pointing forward. Ensure that, where possible, the rear of

the chair is against a wall or, if not, it must be firmly held by an attendant.

4.10.2.3 Engage both hand brakes.

4.10.2.4 Turn the footplates up and swing them to the side.

4.10.2.5 Slide forwards on the seat.

4.10.2.6 Place one foot firmly on the ground with the knee at a right angle and the other foot slightly apart and further back.

4.10.2.7 Place your hands on the front of the armrests and moving your weight forward, bring your head and shoulders up over your knees as you push yourself up.



CAUTION:

- **Never stand on the footplates when getting into (or out of) the chair. (See Figure 4.28)**
- **When getting in and out of the wheelchair, please apply the hand brakes. The hand brake is the lever at the side of the wheelchair.**
- **Please ensure that neither the tread on the tires nor the brake block has become too worn. If pneumatic tires are fitted, please maintain them at the recommended tire pressure for the same reason.**
- **Please ensure that user's fingers do not get caught in the brake.**

When transferring in and out of the chair, make sure that the brakes are applied to prevent the chair from sliding away. Also see that the footplates are flipped up for ease of entering or exiting. (See Figure 4.29)

4.11 General Use

4.11.1 Attendant Pushing and Self-Propelling

4.11.1.1 Do ensure that the brakes are always applied when the chair is not being pushed. (See Figure 4.30)

4.11.1.2 Always make sure that both user's feet are safely on the footplates and that clothing is safely tucked out of the way and cannot get caught in the wheels. (See Figure 4.31)

4.11.1.3 Always use both hands on the push handles to control the chair. (See Figure 4.32)

4.11.1.4 Always avoid steep or uneven surfaces because the chair may tip

over. (See Figure 4.33)

4.11.1.5 Always avoid soft surfaces because the casters may get bogged down. (See Figure 4.34)

4.11.1.6 Always be careful not to go too fast or turn too quickly and try to achieve a smooth steady ride.

4.11.1.7 Before crossing the tracks, please stop completely and look both ways.

4.11.1.8 Cross the tracks perpendicular to avoid your wheels getting stuck.

4.11.1.9 Do not drive at full speed over railroad tracks.

4.11.1.10 Be careful going through a doorway that your hands and arms do not get injured.

4.11.1.11 PLEASE keep in contact with the person in the chair. If you stop to look in shop windows or talk to people, remember to turn the chair so that the person in the chair does not have to turn.

 SUGGESTION:

- NEVER lock the brakes too suddenly as this may tip the user out of the chair.



Figure 4.28



Figure 4.29



Figure 4.30



Figure 4.31



Figure 4.32



Figure 4.33



Figure 4.34



Figure 4.35

4.12 Tilting by the Attendant

- 4.12.1 Make sure both the user's feet are on the footplates and will not slip off. Make sure the handgrips are secure and cannot slip off.
- 4.12.2 Release both brakes.
- 4.12.3 Grasp both push handles firmly.
- 4.12.4 Put your stronger foot on the relevant tipping lever at the back of the chair.
- 4.12.5 Tell the person in the chair that you are about to tilt the chair backwards.
- 4.12.6 Pull back with both hands and push down and forwards with the foot. This will bring the chair onto the rear wheels. (See Figure 4.35)



CAUTION:

- When a chair is tilted to about 25 degrees it will balance on its rear wheels and be easy to hold. If it is tilted further back it will be difficult to hold and the person in the chair will feel unsafe.
- Lower with a straight back; keep your foot on the anti-tipper and lower the chair slowly forwards softly to the ground.

4.13 Tilting by the User

- 4.13.1 Make sure your feet are on the footplates and will not slip off.
- 4.13.2 Release both brakes.
- 4.13.3 Grasp both push rims and give a firm, sudden forward push immediately before the obstacle, continue the momentum (be ready to keep pushing) until the obstacle is mounted.

 CAUTION:

- This method should only be attempted by people experienced in wheelchair use. Sufficient muscle strength is also necessary. It is always better to have the help of an attendant.
- Leaning backwards causes the casters to rise higher BUT it is much safer to lean forwards and stay balanced.

4.14 Going Down Kerbs

4.14.1 Please note: It is always better to avoid kerbs where possible by using ramped kerbs or slopes and this operation is best attempted with the aid of an attendant.

4.14.2 Going Down Kerbs Forwards with an Attendant.

 CAUTION:

- This is the more difficult method and can jar the user but allows a better view of traffic.
- Be careful that the anti-tipper does not get caught on the kerb causing the user to fall.

4.14.2.1 NEVER ALLOW THE CHAIR TO TIP FORWARDS WHEN GOING DOWN A KERB.

4.14.2.2 Position the chair so that the front casters are near the edge of the kerb and make sure that the road is clear.

4.14.2.3 Move the chair slowly and carefully forwards while tilting it back slightly. Be ready to take the weight when the rear wheels cross the kerb edge. Ensure that both rear wheels touch the ground at the same time to avoid tipping the chair.

4.14.2.4 Gently lower the front casters. AVOID JARRING THE USER.

4.14.3 Going Down Kerbs Backwards with an Attendant.

 CAUTION:

- This is the easier and smoother method BUT it requires the attendant to step backwards into the road.

4.14.3.1 Back the chair to the kerb edge and note that the rear wheels are equally near the edge.

4.14.3.2 Grasping the push handles, gently lower the rear wheels onto the road. Be prepared to control the weight as it descends and ensure that the rear wheels touch ground at the same time.

4.14.3.3 Tilt the chair back slightly and pull the tilted chair far enough into the road so that the casters and footrests can be lowered clear of the kerb.

4.15 Going Up Kerbs

Please note: This operation is best attempted with the aid of an attendant and the best method is to go up kerbs forwards as this maintains the direction of travel and is physically less demanding for the attendant.

4.15.1 Going Up Kerbs Forwards with an Attendant

4.15.1.1 As the footrests nearly touch the kerb tilt the chair. The chair should be tilted just high enough to allow the front casters to roll smoothly onto the pavement.

4.15.1.2 Push the chair forward until the rear wheels are touching the kerb. Then, continuing the movement, lift at the push handles while moving the chair forwards.

4.15.1.3 Going Up Kerbs Backwards with an Attendant

4.15.1.4 Please note: for safety's sake we do not recommend using this method.

4.16 Up and Down Steps/Stairs

4.16.1 Please note: avoid flights of steps particularly if no extra help is available. Use ramps or lifts wherever possible.

4.16.2 It requires two attendants to complete this action safely. Each of the attendants should be capable of carrying at least half of the combined weight of the person and the wheelchair.

4.16.3 Each helper should bend at the knees and grip the main frame: with the front attendants hands just under the front of the seat, with the back attendant's hands holding the frame just under the push handles.



CAUTION:

- Don't attempt to lift the wheelchair by any removable (detachable) parts.
- Lifting by means of any removable (detachable) parts of wheelchair may result in injury to the user and/or assistant or damage to the wheelchair.

ALL LIFTING SHOULD BE DONE WITH A STRAIGHT BACK.

Straighten legs to lift the chair. Carefully carry it up or down steps; be aware of how you place your feet -- do not cross them and trip yourself up.

4.17 Transportation

4.17.1 VIP 515 (KM-1520.3T) retrofitted with genuine crash-resistant reinforcement kits has been crash tested to ISO7176-19 (Report No. MBK 09/0257) and is suitable to use as a seat in vehicles that has been adapted for this purpose. The wheelchair must be securely restrained as described in this manual. VIP 515 retrofitted with genuine crash-resistant reinforcement kits was tested with a four point webbing system. For further information on the use of wheelchair restraints, please refer to the manufacturer's user guide.

4.17.2 KARMA always recommend that the user transfers to the vehicle seat, because using a wheelchair as a seat in a vehicle does not provide the equivalent level of safety of a vehicle seating system.



SUGGESTION:

- Please transfer to a vehicle seat in the vehicle in all permitted cases.

4.18 Before use

CAUTION:

- The VIP 515 retrofitted with genuine crash-resistant reinforcement kits was tested with a four point webbing system, with the back in the upright position. Please leave the headrest in place during transportation.

4.18.1 Please detach all easily removable accessories from the wheelchair and stow them in a safe place where they cannot move around and become a safety hazard.

4.18.2 Please remember to install the tie-down bracket kits before using the four point webbing systems. The below photo illustrates the installation location of tie-down bracket kits. For further information, please contact your local dealers for assistance.



4.18.3 A four point tie-down system should tightly fasten to the lower wheelchair frame marked with a yellow sticker as pictured.

4.18.4 An occupant restraint system using both a pelvis and harness must also be fastened to the transport vehicle to insure user safety. Please refer to the restraint system's instructions.



4.18.5 The attendant / transporter must double-check all fastening points for proper connection and tightness to assure the wheelchair users safety. The attendant / transporter must be fully cognisant of the fastening system's usage and its weight limitations.

4.18.6 See <http://www.unwin-safety.com/> for more information.

 **WARNING:**

- VIP 515 retrofitted with genuine crash-resistant reinforcement kits has passed the crash test. Do not use the wheelchair as a seat in a vehicle if there is no crash tested labels of hook mark on the chair.

4.19 Method of Restraint

4.19.1 VIP 515 retrofitted with genuine crash-resistant reinforcement kits was tested with four point webbing systems, with the back in the upright position. Please refer to the restraint manufacturer's user guide for further details of its operation.

4.19.2 Fitting the front restraint

4.19.2.1 Connect the straps around the wheelchair frame and caster bracket as pictured below. The anchor point is marked with a yellow sticker.

4.19.2.2 Take the brakes off and reverse the wheelchair to tension the front straps. Apply the wheelchair brakes (the brakes should be left on during transport)

4.19.3 Fitting the rear restraint

4.19.3.1 Attach rear straps into the rail approximately 300 mm behind the wheelchair backrest.

4.19.3.2 Attach the hooks to the wheelchair tie-down brackets at the rear of the wheelchair as pictured below. Tension the restraint until the wheelchair is secure.



Fitting the front restraint



Fitting the rear restraint

4.20 Fitting the Seat Belt

4.20.1 Fasten the three point safety belt around the user.

4.20.2 The occupied wheelchair should be located in a forward-facing configuration, with the parking brake applied.

4.20.3 Pelvic restraints should make full contact across the front of the body near the junction of the thigh and pelvis as pictured below (correct seat belt position).

4.20.4 Restraints should not be held away from body by wheelchair components such as armrest or wheels as pictured below (Incorrect seat belt position).

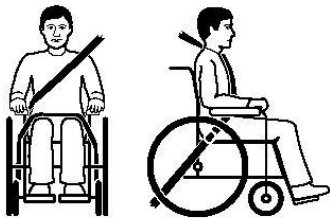

Correct seat belt position



Incorrect seat belt position

4.21 Safety Belt

4.21.1 How to assemble and disassemble the Safety Belt

4.21.1.1 Loosen the fourth and fifth screws of both side of seat upholstery and insert the Safety Belt in between the fourth and fifth screw holes. (Figure 4.36)

4.21.1.2 Keep the safety Belt in 45 deg for comfortable usage. (Figure 4.37)

4.21.1.3 Put the seat upholstery back and tighten the screws.

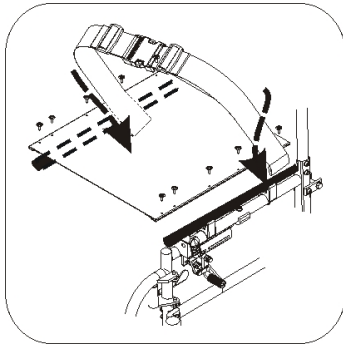

Figure 4.36

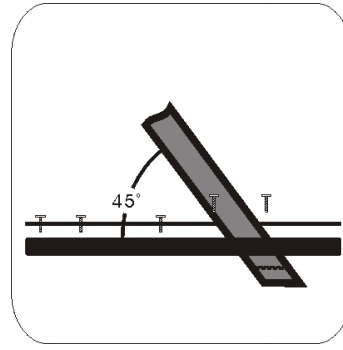

Figure 4.37

4.21.1.4 Adjusting the length of seat belt

4.21.1.5 Identify the require length of the belt. (Figure 4.38)

4.21.1.6 Push the two parts of the belt through buckle to make the belt longer or shorter. (Figure 4.39)

4.21.1.7 Pull the two parts of belt tight. (Figure 4.40)

4.21.1.8 Push the buckle up to the plastic clip so that the belt can not slip out of position. Please check that there is no gap between the clip and the buckle. (Figure 4.41)

i SUGGESTION:

- We recommend that the belt is fitted quite tightly around the pelvis. Please tighten until you can just get your fingers between the user and the seat belt. Please check that the belt is fastened correctly as recommended. If this is not possible, please consult your supplier.



Figure 4.38



Figure 4.39



Figure 4.40



Figure 4.41

4.22 How to Operate the Seat Belt

4.22.1 When you sit on the wheelchair, fasten the safety belt.

4.22.2 Adjust the belt and make it fit your body for comfort and security.

4.22.3 When you don't use it, please fasten the belt to avoid the belt dropping into rear wheels during motion.

4.22.4 Maintenance

4.22.4.1 The safety belt is made from 100% polyester fibre and the clasp is made from plastic.

4.22.4.2 It does not require any maintenance but should be inspected every month to ensure that the edges are not frayed and weekly to make sure that it correctly fits the user. If there are any signs of deterioration, please replace it immediately.

5. INSPECTION AND MAINTENANCE

5.1 Daily Check

- 5.1.1 Check the following items before traveling. If you find anything abnormal, visit your KARMA wheelchair dealer for further inspection before using it.
- 5.1.2 Examine the brakes, checking for any wear, damage and misalignment. Replacing or adjusting the brakes should be carried out by your approved repairer.
- 5.1.3 Check that the hand grips are not damaged and are securely bonded to the push handles.
- 5.1.4 Check the anti-tippers are not damaged and are securely attached.
- 5.1.5 Check that the anti-tippers' wheels and frame are not damaged and are securely mounted.
- 5.1.6 Check that the headrest screws are tightened.
- 5.1.7 Before using the wheelchair, make sure all nuts and bolts are tight. Check all parts for damage or wear and have a qualified technician replace it if necessary. Check all parts for proper adjustment.
- 5.1.8 Inspect the brakes for proper operation.
- 5.1.9 The wheels and tires should be checked periodically for cracks and wear, and should be replaced by a qualified technician.
- 5.1.10 A qualified technician can be found with an authorized distributor/dealer.



CAUTION:

- Visit a KARMA wheelchair dealer for inspection and maintenance if you find anything abnormal.

5.2 Regular Maintenance Record

- 5.2.1 In order to ensure that your wheelchair is in good condition, please contact KARMA authorized dealers regularly and make further wheelchair inspection and maintenance records. We recommend that you inspect and maintain your wheelchair **every six months**.

5.2.2 A maintenance/service fee may apply.

i SUGGESTION:

- Even if you don't use the vehicle for a long time, the wheelchair should still be maintained regularly. You should clean your wheelchair regularly to keep it clean and safe.

Item	Weekly	Monthly
GENERAL		
● Wheelchair rolls straight (no excessive drag or pull to one side)		✓
FRAME AND CROSS BARS		
● Inspect the frame structure for small cracks/fissures		✓
● Inspect for bent frame or cross bars		✓
BRAKES		
● Do not interfere with tires when rolling		✓
● Pivot points free of wear and looseness		✓
● Easy to engage	✓	
● Prevent the chair from moving when engaged	✓	
HEADREST, SEAT & BACKREST		
● Inspect for rips or sagging	✓	
● Inspect for loose or broken hardware		✓
CASTERS		
● Inspect the casters for smooth rotation of the caster wheel and caster assembly		✓
● Inspect the caster for wear in the bearings/mountings and for tire wear or damage		✓
REAR WHEELS		

<ul style="list-style-type: none"> ● Quick-release axles lock properly; lubricate if necessary ● No excessive side movement or binding when lifted and spun ● Inspect for any cracked, bent or broken spokes 	 V V	 V
ARMRESTS		
<ul style="list-style-type: none"> ● Inspect the detachable armrest button for effective locking ● Make sure the armrest detaches and flips back properly 		 V V
FOOTRESTS		
<ul style="list-style-type: none"> ● Inspect the footplate height adjustment screws are securely tightened ● Inspect the swing-away footrest release lever for effective locking 		 V V
TIRES		
<ul style="list-style-type: none"> ● Inspect for flat spots, cracks and wear ● If pneumatic tires, check for proper inflation ● Check tire tread depth is more than 1mm ● Check tire pressure; tire pressures are specified on the side of the tire 	 V V V	 V

 CAUTION:
<ul style="list-style-type: none"> ● As with any wheelchair, the wheels and tires should be checked periodically for cracks and wear, and should be replaced. ● Failure to keep tires at the correct pressure will reduce the braking efficiency. ● Never disassemble or modify the wheelchair frame structure. Otherwise, injury or damage may occur. This will void the warranty.

6. OPTIONS AND ACCESSORIES



- I.V. Pole Holder
- Adjustable height from 130cm (51") to 200cm (78").
- Attaches to all KARMA manual wheelchairs.



- Oxygen Holder
- Standard size attaches to the back of wheelchairs.
- Attaches to all KARMA manual wheelchairs.



- Backrest Bag
- Standard size.
- Attaches to all KARMA manual wheelchairs.



- Folding Drink Holder
- Collapses and adjusts to the size of the container (6-10cm).
- Attaches to all KARMA manual wheelchairs.



- Multi-Purpose Safety Belt
- Attaches to all KARMA manual wheelchairs.



CAUTION:

- Attaching accessories may alter the overall stability and center-of-gravity of the chair. Thus, this should be performed by your approved repairer and therapist.

7. TROUBLESHOOTING

Trouble or Problems with Your Wheelchair

You can inspect the following before taking your wheelchair to a KARMA wheelchair dealer.

Problem	Checking Points and Corrective Action
1. Chair Veers Right/Left	<ul style="list-style-type: none">● Check tires for correct and equal pressure● Check caster bracket angle● Check that rear wheels are equally spaced from the seat frame
2. Sluggish Turn or Performance	<ul style="list-style-type: none">● Check tires for correct and equal pressure● Check for loose nuts and bolts
3. Caster Flutter/Wobble	<ul style="list-style-type: none">● Check tires for correct and equal pressure● Check for loose nuts and bolts● Check caster bracket angle
4. Squeaks and Rattles	<ul style="list-style-type: none">● Check for loose nuts and bolts
5. Looseness in Chair	<ul style="list-style-type: none">● Check for loose nuts and bolts

If you cannot solve the problem by yourself, contact your KARMA wheelchair dealer for help.

8. SPECIFICATIONS

Product Model	VIP 515 (KM-1520.3T)			
Nominal seat width (in)	16	18	16	18
Caster x Rear wheel size (in)	7 x 14		7 x 20	
Maximum user weight (kg)	115			
Overall length with legrest (mm)	1070	1070	1070	1070
Overall width (mm)	635	680	660	710
Overall height (mm)	955 / 1325 (with headrest)		955 / 1330 (with headrest)	
Folded length (mm)	725	730	790	790
Folded width (mm)	350	350	375	375
Folded height (mm)	760	760	760	760
Total mass (kg)	18.9	19.3	20.0	20.3
Mass of the heaviest part (kg)	15.1	15.3	16.2	16.4
Handrim diameter (mm)	N/A	N/A	430	430
Horizontal location of axle (mm)	6	6	6	6
Minimum turning radius (mm)	835	845	860	870
Minimum turning radius without user (mm)	815	825	820	835
Pivot width (mm)	1180	1200	1210	1230
Static stability downhill (X°)	16		N/A	
Static stability uphill (X°)	16		N/A	
Static stability uphill with anti-tippers (X°)	20		N/A	
Static stability sideways (X°)	13		N/A	
Seat plane angle (X°)	1 ~ 37			
Effective seat depth (mm)	420	420	420	420
Nominal seat depth (mm)	415	415	415	415
Effective seat width (mm)	475	520	475	520
Seat surface height at front edge (mm)	490	485	490	485
Backrest angle (X°)	13			

Seat to backrest angle (X°)	94			
Backrest height (mm)	460	460	460	460
Headrest height above seat (mm)	600 ~ 740	600 ~ 740	600 ~ 740	600 ~ 740
Leg to seat angle (X°)	114			
Footrest to seat distance (mm)	405 ~ 480	405 ~ 480	405 ~ 480	405 ~ 480
Armrest to seat distance (mm)	240 ~ 320	240 ~ 320	240 ~ 320	240 ~ 320
Front location of armrest structure (mm)	370	370	370	370

* The actual product specifications differ from the data in the table by ± 1 cm ± 0.5 kg.

* The actual product specifications may vary according to different configurations.

* KARMA reserves the right to modify information herein without further notice.

* If you want to know more about the measurement methods of wheelchair specifications, please scan the QR code to watch the instructions on the KARMA website.



CAUTION

Please do not travel across any slope (in any direction) greater than 7 degrees.

9. CLEANING & RECYCLING

9.1 Cleaning

In order to lengthen the life of your wheelchair, it is suggested that you clean the wheelchair periodically (if not daily), especially after it is used in the rain or snow. We suggest that you don't use your wheelchair in the rain or snow. If you are traveling and get caught in the rain, we suggest you try to find a shelter while waiting it out. If you can't find any, proceed to your destination.

9.2 Frame

Wipe it with a damp cloth.

9.3 Upholstery

When cleaning the upholstery, use warm water and a mild soap.

Upholstery cleaner/foam can also be used, but avoid other cleaning solvents.

9.4 Post-Consumer Recycling

A post-consumer recycling plan should follow the Environmental Protection Administration's regulations. The items listed below are for reference only as local laws and regulations may vary.

Material	Part Name	Method
Aluminum-alloy	Frame	Recyclable
Plastic	Modular Components	Recyclable
Paper	Owner's Manual	Recyclable

9.4.1 There are many organizations in many countries you can find on the Internet that will accept used goods for charity.

9.4.2 Please search the information highway to help less fortunate individuals and protect our planet for future generations.

9.4.3 If you do not have access to the world wide web please use your local phone directory, ask for operator assistance or go to your local government center for more information. Earth Day is every day.

9.4.4 Check with your local recycling center on where and how to recycle your wheelchair as this information varies from region to region.

10. WARRANTY

10.1 Serial Number

To ensure after-sale service and warranty, please record and fill in the serial number which can be found on the frame.

This warranty is VOID if the original chair serial number is removed or altered.

Model	
Serial Number	

10.2 Warranty Policy

10.2.1 Contents and Duration of Warranty

10.2.1.1 If the parts of the product need to be repaired or replaced due to manufacturing defects, they can be repaired or replaced free of charge within the warranty period (a repair of this kind will hereafter be called warranty maintenance).

10.2.1.2 Frame and cross-braces are warranted for a period of 5 years and gas strut for a period of 1 year after delivery to the customer, then the affected parts will be repaired or replaced free of charge.

10.2.1.3 Consumable parts such as brakes, bearings, footplates, pads, side guards, upholsteries, wheels and similar parts are excluded from the warranty.

10.2.1.4 Warranty maintenance can be performed by authorized KARMA wheelchair dealers only.

10.2.1.5 KARMA is not responsible for the transportation costs for repair and replacement.

10.2.1.6 Warranty maintenance is the repair or replacement according to the condition of the parts, and replaced parts will be the property of KARMA.

10.2.1.7 KARMA reserves the right to modify product specifications without further notice; KARMA is not responsible for any changes to product specifications.

10.2.2 The Claims from This Warranty Shall Not Arise for The Following

Reasons

10.2.2.1 The product or part has been damaged by accident, improper use, incorrect assembly or poor maintenance. The evaluation of it is the privilege of KARMA.

10.2.2.2 Damage resulting from normal wear and tear.

10.2.2.3 Any overloading of the product, please check the label for maximum user weight.

10.2.2.4 The product or part has not been maintained or serviced in accordance with the manufacturer's recommendations as shown in the User Manuals and/or the Service Manuals.

10.2.2.5 Use or install parts or accessories which are not manufactured or not approved by KARMA.

10.2.2.6 Damage resulting from use in unsuitable environments.

10.2.2.7 Damage resulting from any addition, modification, or alteration of the product or parts without the approval by KARMA.

10.2.2.8 Damage resulting from external factors, such as chemicals, oil, debris, etc.

10.2.2.9 Damage caused by natural disasters.

10.2.3 KARMA is Not Responsible for The Following Costs

10.2.3.1 Replacement or refill of consumable parts, oil or lubricant.

10.2.3.2 Product inspection, adjustment, lubrication, cleaning, etc.

10.2.3.3 The costs of regular inspection and maintenance of product.

10.2.3.4 The product is not repaired by the authorized dealer designated by KARMA.

10.2.4 Responsibilities

10.2.4.1 The Responsibilities of the User

10.2.4.1.1 Fully adhere to operation guidelines set forth in this manual.

10.2.4.1.2 Perform self-inspection and basic maintenance.

10.2.4.1.3 Keep a record of self-inspections and basic maintenance.

10.2.4.1.4 Not permit any alteration, addition, or modification or use of parts not manufactured by KARMA.

10.2.4.1.5 Thoroughly read and understand this manual.

10.2.4.2 The Responsibilities of the Dealer

10.2.4.2.1 Follow this owner's manual and educate user about product operation and basic maintenance

10.2.4.2.2 Verify and check whether the warranty conditions are met.

10.2.4.2.3 Provide relevant warranty information and recommendations for improvements.

10.2.5 Transfer of Warranty Rights

If you purchase a second-hand KARMA wheelchair while it is still within the warranty period, bring this user manual and the wheelchair to the authorized dealer and perform necessary product inspection, maintenance and warranty inheritance procedure.

Full Name:	
Gender:	
Date of Birth:	
Address:	
Model:	
Serial Number:	
Date of Purchase:	

Dealer's Data

Name of the Store:	
Telephone No. & Address:	

If you have any suggestions on how to improve our products, please don't hesitate contacting your local dealer to let us know what you think of your wheelchair. Thank you and enjoy.

karma

A Better Wheelchair, A Better Fit



KARMA MOBILITY S.L European Support Center.
www.karmamobility.es
+34 984 390 907
karma@karmamobility.es

KARMA MOBILITY LTD. UK representative
www.karmamobility.co.uk
+44 845 630 3436
info@karmamobility.co.uk

KARMA MEDICAL PRODUCTS CO., LTD.
www.KarmaMedical.com
+886 5 206 6688
globalsales@karma.com.tw