

*User manual*

## **Saber GT Series**

*(KP-45.6 · KP-45.6T · KP-45.6TR)*





## GENERAL WARNING

### IMPORTANT

Do not attempt to use the wheelchair before a qualified person has explained to your satisfaction how to operate it without risk to yourself or others.



#### WARNING

- Do not operate this equipment without first reading and understanding this manual. If you are unable to understand the warnings, cautions and instructions, contact a dealer, healthcare professional or technical personnel if applicable before attempting to use this equipment --otherwise, injury or damage may result. Procedures other than those described in this manual must be performed by a qualified technician.

THE INFORMATION CONTAINED IN THIS DOCUMENT IS SUBJECT TO CHANGE WITHOUT NOTICE.



#### WARNING

- As a manufacturer of powered wheelchairs, KARMA endeavors to supply a wide variety of powered wheelchairs to meet the many needs of the user. However, the responsibility of final selection of the type of powered wheelchair to be used by an individual rests solely with the user and his/her healthcare professional capable of making such a selection.
- As of this date, this wheelchair has NOT been tested for safety in collisions according to ISO-7176-19:2001. Therefore, this wheelchair CANNOT be used as seats in any vehicles. That is, KARMA recommends that users are NOT transported in any vehicle while seated in the wheelchair. In the case of accident or a sudden stop, the user could be thrown from the chair and get injured. The suggested solution is to move the user from the wheelchair into a normal seat of the vehicle and to securely stow the wheelchair in a separate compartment.

### Operating Information

- Performance adjustments should ONLY be made by professionals of the healthcare field or persons fully conversant with this process and the driver's capabilities. Incorrect settings could cause injury to the driver or bystanders and damage to the powered wheelchair and surrounding property.
- To determine and establish your particular safety limits, practice bending, reaching, mounting and dismounting activities in several combinations in the presence of a

qualified healthcare professional BEFORE attempting active use of the powered wheelchair.

- For individuals with balance problems, practice mounting and dismounting activities WITH AN ASSISTANT in the presence of a qualified healthcare professional.
- If so equipped, DO NOT operate the wheelchair without anti-tippers being installed. Anti-tippers MUST BE attached at all times.
- DO NOT attempt to reach objects if you have to move forward in the seat or pick them up from the floor by reaching down between your knees as this may cause loss of balance.
- DO NOT lean over the back of the chair to reach objects behind you as this may cause the powered wheelchair to tip over.
- DO NOT shift your weight or sitting position toward the direction you are reaching as the powered wheelchair may tip over.
- DO NOT use an escalator to move a powered wheelchair between floors. Serious bodily injury may occur.
- DO NOT operate in car lanes on roads, streets, highways, etc.
- DO NOT attempt to move up or down an incline with a water, ice or oil film.
- DO NOT attempt to ride over curbs or obstacles. Doing so may cause your powered wheelchair to turn over and cause bodily harm and/or damage to the powered wheelchair.
- DO NOT make sharp turns, in forward or reverse, at excessive speeds.
- DO NOT attempt to lift the powered wheelchair by its casings and seat.
- DO NOT attempt to lift the powered wheelchair by any detachable parts. Lifting by any detachable parts of a powered wheelchair may result in injury to the user or damage to the powered wheelchair. Please hold onto the frame when lifting your wheelchair.
- DO NOT operate the powered wheelchair until you have checked that the surroundings are clear and that the area is safe for travel.
- Please pay attention to the environment, and to keep away from the hazard of external flame. When the user is smoking, pay attention to safety and make sure to extinguish the fire when finished. Be alert to the environment when someone nearby is smoking or using a cigarette lighter, keep away from the hazard and use fire-proof cloth.
- DO NOT use parts, accessories or adapters other than those authorized by Karma. Before attempting to sit in or exit the powered wheelchair, turn the power OFF. This will ensure that the powered wheelchair will not drive. Turn the power OFF while the wheelchair is not in use. Otherwise, injury and/or damage to the wheelchair and surrounding property may occur.
- DO NOT connect any medical device (i.e., a ventilator, life support machine, et

cetera) to the battery. This could cause unexpected failure of the device and the powered wheelchair. KARMA specifically disclaims responsibility to all personal injury and property damage that may occur during use which does not comply with applicable federal, state and local laws and ordinances.

- DO NOT stand on the footplates of the powered wheelchair.
- DO NOT use the wheelchair when the back is folded. This alters the center of gravity and may cause the wheelchair to tip backwards. The back should only be folded for storage or transport of the wheelchair.
- DO NOT hang anything on the back joints that could cause the backrest folding suddenly and may cause injury.
- DO NOT be towed by other vehicles(cars, motorcycles or bicycles, etc.). Only use freewheel mode on flat surfaces since your electromagnetic brakes are not engaged in this mode, without these brakes it will roll down a hill causing injury or damage. Never drive under the influence of alcohol or medication.
- DO NOT sit in the powered wheelchair within a moving vehicle unless it has been affixed the labels of hook mark. The labels of hook mark means that the powered wheelchair fulfils the performance requirements for a "Crash Test" of ISO 7176-19 and is suitable to use as a seat in vehicles that have been adapted for this purpose.
- Store your chair in a clean, dry area. If you fail to do so, parts may rust or corrode.
- *The force necessary to operate the freewheel lever is less than 60N.*
- *We estimate a life expectancy of five years for the product, provide it is used strict accordance with the intended use as set out in this document and all maintenance and service requirements are met. The estimated life expectancy can be exceeded if the products is carefully used and properly maintained. The life expectancy can be reduced by extreme or incorrect usage.*

## RAMPS

- DO NOT climb, go up or down ramps or traverse slopes greater than the "safe slope" for your model specified in Section 10.
- When negotiating ramps, if the joystick is released while moving forward, the powered wheelchair will roll backwards approximately one foot before the brake engages. If the joystick is released while in reverse, the powered wheelchair will roll backwards approximately two and a half feet before the brake engages.
- Be sure to reduce your speed when driving on curved roads or making a turn; do not drive at full speed. Please drive at a slower speed so you have complete control of the wheelchair.

## ELECTRICAL

- Check to ensure that all electrical connections are secure at all times.
- Grounding Instructions: DO NOT, under any circumstances, cut or remove the round grounding prong from any plug. Some devices are equipped with three-prong (grounding) plugs for protection against possible shock hazards.
- Where a two-prong wall receptacle is encountered, it is the personal responsibility and obligation of the customer to contact a qualified electrician and have the two-prong receptacle replaced with a properly grounded three-prong wall receptacle/outlet in accordance with the National Electrical Code and local laws.
- Do not use an extension cord when charging your batteries. A risk of fire and /or electric shock could be encountered.

## BATTERIES

- There are two types of batteries can be selected, deep cycle sealed lead acid batteries or Li-ion batteries. The warranty and performance specifications contained in this manual are based on the type of batteries. \_
- KARMA strongly recommends their use as the power source for this unit. (Refer to Section 6)
- Carefully read the battery and charger information prior to installing, servicing or operating your wheelchair.

## RAIN TEST

- DO NOT leave your powered wheelchair in a rain storm of any kind.
- DO NOT use your powered wheelchair in a shower or leave it in a damp bathroom while taking a shower.
- DO NOT leave your powered wheelchair in a damp area for any length of time. Direct exposure to rain or dampness could cause the powered wheelchair to malfunction electrically and mechanically and may cause the powered wheelchair to prematurely rust.

## STAIRWAYS

- DO NOT attempt to move an occupied powered wheelchair between floors using a stairway. (See Figure 1)
- Use an elevator to move an occupied powered wheelchair between floors. If moving a powered wheelchair between floors by means of a stairway, the occupant MUST be removed and transported independently of the powered wheelchair. Extreme caution is advised when it is necessary to move an UNOCCUPIED powered



(Figure 1)

wheelchair up or down stairs.

- Karma recommends disassembling the wheelchair and transporting the components independently up or down stairs. Make sure to use ONLY secure, non-detachable parts on each component for hand-hold supports.
- DO NOT attempt to lift a powered wheelchair by any removable (detachable) parts. Lifting by means of removable (detachable) parts may result in injury to the user or assistants or damage to the wheelchair.

## **ESCALATORS**

- DO NOT use an escalator to move a powered wheelchair between floors. Serious bodily injury and damage to the wheelchair may occur.

## **YOU AND YOUR KARMA SERVICE PROVIDER**

- No tools are required for assembly. Your wheelchair should be assembled by your authorized Karma dealer. Your authorized Karma dealer is also your service provider. Unauthorized repairs, upgrades and add-ons will void your warranty.
- Anything wheelchair related that requires tools should be done by your authorized Karma service provider. Your Karma service provider has the necessary service manual for your wheelchair.
- If you have any defective parts or lose any parts, please contact your dealer for repair and/or replacement. Please only use parts authorized by Karma. Use of parts that are not authorized by Karma will void your warranty.
- Part numbers are listed on our bill of materials (explosion drawings), which we give to our authorized dealers and service providers. Customers should order parts through their dealer as well as all repairs and scheduled maintenance.
- Customers should go to their dealership for all service needs to guarantee their warranty is not void. Always go to an authorized service provider. Unauthorized repairs will void your warranty. Procedures other than those described in this manual must be performed by a qualified technician. They also have the service manual with a complete list of maintenance required to keep your Karma wheelchair in top performance.
- Check the warranty section of this manual to find out what Karma guarantees and what maintenance service and parts that are not covered by the warranty.
- Karma does not have an official list of service providers at this time. Please contact your dealer for service. If you cannot contact your dealer, please contact another authorized Karma dealer for service. If all else fails, contact Karma directly via our website or give us a call and we can refer you to your new service provider.

## CLASSIFICATION & INTENDED USE

- This wheelchair is classified as a class B mobility product for indoor and outdoor use. This wheelchair is suitable for users up to 135 kg in weight. It also has an extremely durable aluminum alloy frame with tough accessory and does not suffer in dramatic extremes of temperature (neither user nor attendant need touch metal parts in normal use).
- Check with your local government as to legislation pertaining to mobility vehicles to assure your legal requirements to drive on public roads have been met, i.e. a pelvic belt, lighting, registration or licensing.

## CE MARKING

- This powered wheelchair complies with the requirements of Medical Devices Regulation (EU) 2017/745.



### CAUTION

- When prescribing wheelchairs for use by full or partial amputees (above or below knee, single or double) or other conditions that affects the user's natural center of gravity and might cause the wheelchair to tip or the person on the wheelchair to fall off, we suggest contacting your therapist or dealer as well as attaching anti-tippers, pelvic belt, or other additional safety accessories.
- When using the wheelchair, **ALWAYS** follow the Highway Code or your local traffic regulations when outdoors and the guidelines written in this manual.



# DECLARATION OF CONFORMITY

## EU Declaration of Conformity

We, with the information specified in the below,

### Our information as the manufacturer:

Manufacturer's Name: KARMA MEDICAL PRODUCTS CO., LTD

Manufacturer's Address: NO. 2363, Sec. 2, University Rd., Min-Hsiung Shiang, Chia-Yi County, 62144, Taiwan

SRN (Single Registration Number): TW-MF-000013206

### Our authorized representative:

Name: KARMA MOBILITY, S.L.

SRN (Single Registration Number): ES-AR-000004852

Address: C/ PERIODISTA FRANCISCO CARANTOÑA  
DUBERT, 23 Bajo  
33209 GIJÓN – ASTURIAS, SPAIN

Contact Person: Raquel Yuste

Contact Information: (+34) 984 390 907

in accordance with

### Regulation (EU) 2017/745 of the European Parliament and of the council Annex I, II, III, IV and IX

hereby declare that the medical device specified below:

**Basic UDI-DI of Annex VI:** 471987385KP-4LE

**Device:** Electrically powered wheelchair

**Trade Name or Mark:** Saber GT series

**Model Number:** KP-45.6

**Product Code according to EMDN:** Y122127

**Product Code according to GMDN:** 41877

**Classification:** Rule 1 of Class I

**UDI-DI:** 04719873856725

# DECLARATION OF CONFORMITY



Document No.: DOC-KP-45.6-01

is in conformity with the applicable requirements of the following documents:

Ref. No.	Title	Edition date
ISO 13485	Medical devices - Quality management systems - Requirements for regulatory purposes	2016
ISO 14971	Medical devices - Application of risk management to medical devices	2019
EN 12182	Assistive products for persons with disability - General requirements and test methods	2012
EN 12184	Electrically powered wheelchairs, scooters and their chargers - Requirements and test methods	2014
EN 62366	Medical devices - Application of usability engineering to medical devices	2015
EN 60601-1	Medical electrical equipment - Part 1: General requirements for basic safety and essential performance	2006
EN ISO 10993-1	Biological evaluation of medical devices - Part 1: Evaluation and testing within a risk management process	2009
EN ISO 10993-5	Biological evaluation of medical devices — Part 5: Tests for in vitro cytotoxicity	2009
EN ISO 15223-1	Medical devices - Symbols to be used with medical device labels, labelling and information to be supplied - Part 1: General requirements	2016
MEDDEV. 2.7/1 Rev. 4	CLINICAL EVALUATION: A GUIDE FOR MANUFACTURERS	2016
MEDDEV 2.12/1 Rev. 8	GUIDELINES ON A MEDICAL DEVICES VIGILANCE SYSTEM	2013

The information on this declaration has been stated on the sole responsibility of KARMA MEDICAL PRODUCTS CO., LTD.

We hereby declare that the device named above has been designed to comply with the relevant sections of the above referenced specifications. The device complies with all General Safety and Performance Requirements.

Date of issue: 4<sup>th</sup> October 2021

Place of issue: NO. 2363, Sec. 2, University Rd., Min-Hsiung Shiang, Chia-Yi County, 62144,  
Taiwan

  
Richard Chang, CEO

# TABLE OF CONTENTS

1. PREFACE.....	1
2. SAFETY .....	2
2.1 BEFORE DRIVING.....	2
2.2 TRAFFIC RULES .....	2
2.3 PRACTICE DRIVING.....	2
2.4 NO PASSENGERS.....	2
2.5 NO HAULING HEAVY GOODS .....	2
2.6 RAIN.....	3
2.7 WHILE DRIVING .....	3
2.8 GENERAL WARNING.....	3
2.9 RAILROAD CROSSING.....	3
2.10 CIRCUMSTANCES TO AVOID.....	3
2.11 MOBILE PHONES AND OTHER ELECTRIC EQUIPMENT .....	3
2.12 RAMPS, INCLINES AND DROPS.....	4
2.13 MAXIMUM USER WEIGHT LIMIT .....	5
2.14 SERVICE LIFE.....	5
2.15 LABELING.....	6
3. EMI/RFI .....	7
3.1 ELECTROMAGNETIC INTERFERENCE FROM RADIO WAVE SOURCES.....	7
3.2 THE SOURCES OF RADIATED EMI CAN BE BROADLY CLASSIFIED INTO THREE TYPES.....	8
3.3 POWERED VEHICLE ELECTROMAGNETIC INTERFERENCE (EMI).....	8
3.4 WARNINGS .....	9
4. PARTS.....	10
5. OPERATION .....	12
5.1 HOW TO OPERATE YOUR WHEELCHAIR.....	13
5.2 HOW TO ADJUST YOUR WHEELCHAIR.....	21
6. BATTERIES AND CHARGER.....	27
6.1 CHARGING THE BATTERIES.....	27
6.2 CHARGE YOUR BATTERIES IF ANY OF THE FOLLOWING CONDITIONS OCCUR.....	27
6.3 CHARGER.....	29
6.4 BATTERIES.....	31
6.5 CLEANING THE BATTERIES.....	32



7. INSPECTION AND MAINTENANCE .....	34
7.1 DAILY CHECK.....	34
7.2 REGULAR MAINTENANCE RECORD.....	34
7.3 TIRES .....	36
7.4 GENERAL MAINTENANCE .....	36
7.5 SUGGESTED MAINTENANCE PROCEDURES.....	37
7.6 TRANSPORTING AND STORING .....	38
7.7 KP-45.6T(R) INSTRUCTIONS FOR LUBRICATION .....	38
8. TROUBLESHOOTING .....	40
8.1 VR2 CONTROLLER, BATTERY & DIAGNOSTICS INDICATOR.....	41
9. SPECIFICATIONS .....	43
10. CLEANING & RECYCLING.....	45
10.1 CLEANING.....	45
10.2 POST-CONSUMER RECYCLING.....	45
11. WARRANTY .....	47
11.1 SERIAL NUMBER.....	47
11.2 CONTENTS AND DURATION OF WARRANTY.....	47
11.3 THE CLAIMS FROM THIS WARRANTY SHALL NOT ARISE FOR THE FOLLOWING REASONS .....	47
11.4 THE RESPONSIBILITIES OF THE USER.....	48
11.5 THE RESPONSIBILITIES OF THE DEALER.....	48
11.6 TRANSFER OF WARRANTY RIGHTS.....	49

# 1. PREFACE

Please carefully read this owner's manual before using the wheelchair. Improper use of the wheelchair could result in harm, injury or traffic accidents. Therefore, for safe and enjoyable use of the wheelchair, please read this owner's manual.

1.1 This owner's manual includes operation instructions for the aspects of the wheelchair, assembly instructions, and instructions on how to deal with possible accidents. This owner's manual is written for Karma powered wheelchair(s): Saber series.

1.2 The symbols used in this manual are explained below. Pay special attention to the parts marked with these symbols.

 <b>WARNING</b>	<b>Improper use could lead the user to severe injury or death.</b>
 <b>CAUTION</b>	<b>Improper use could lead the user to severe injury and/or damage to your wheelchair.</b>
 <b>SUGGESTION</b>	<b>Follow these instructions to keep the wheelchair in good condition.</b>

1.3 This manual includes the repair and maintenance chart as well as the Warranty. Please keep it in a safe place or with the wheelchair.

1.4 If someone else uses the wheelchair, make sure that you give him or her this owner's manual for his or her reference.

1.5 As designs change, some illustrations and pictures in this manual may not correspond to the vehicle that you purchased. We reserve the right to make design modifications without further notice.

## **2. SAFETY**

### **2.1 Before Driving**

2.1.1 The user must be familiar with the use and operation of this wheelchair before driving.

2.1.2 Therefore, please always keep these safety guidelines in mind.

### **2.2 Traffic Rules**

2.2.1 Pedestrian traffic rules apply to this wheelchair. Please be safe.

2.2.2 Drive only on pedestrian areas such as the sidewalk. Never drive the wheelchair on the highway.

2.2.3 Be aware of other vehicles when crossing all roads.

2.2.4 Be extremely cautious when driving your wheelchair in heavy traffic or the shopping mall.

2.2.5 DO NOT drive your wheelchair when you feel tired or consume alcohol.

2.2.6 Please do not drive your wheelchair at night.

2.2.7 Please follow pedestrian traffic lights.

### **2.3 Practice Driving**

2.3.1 Before you are familiar with the operation of your wheelchair please practice in a wide and open area, like a park.

2.3.2 To avoid falling off your wheelchair please practice all kinds of driving motions, such as accelerating, stopping, turning, reversing and going up and down ramps.

2.3.3 Please set the speed to medium when you first start practicing.

2.3.4 Be safe. Make sure someone accompanies you in case you need assistance.

2.3.5 Be sure you are able to control and operate your wheelchair easily and confidently before you move the speed higher.

### **2.4 No Passengers**

2.4.1 KARMA wheelchair is limited to one driver. Do not carry passengers (including children) on your wheelchair.

### **2.5 No Hauling Heavy Goods**

2.5.1 Do not use this wheelchair to carry or haul heavy goods. The maximum weight that this wheelchair can carry, including any items carried on the powered wheelchair, is stated beside "Max. User Weight" in Section 10.

## SPECIFICATIONS.

### **2.6 Rain**

2.6.1 This product is not guaranteed to be water resistant. Please do not drive in the rain, through puddles or spray water to clean this product. (See Figure 2.1)

### **2.7 While Driving**

2.7.1 Please carry out daily inspections. Refer to Section 7.1 DAILY CHECK.

### **2.8 General Warning**

2.8.1 Do not lean over the side of the wheelchair as such an action may cause you to lose balance and fall.

2.8.2 Use caution to assure your clothing doesn't get tangled with the wheels.

### **2.9 Railroad Crossing**

2.9.1 Before crossing the tracks, please stop completely and look both ways.

2.9.2 Cross the tracks perpendicular to avoid your wheels getting stuck.

2.9.3 Do not drive at full speed over railroad tracks.

### **2.10 Circumstances to Avoid**

2.10.1 Avoid roads with heavy traffic, mud, excessive gravel or bumps, snow and ice. These conditions may damage your wheelchair.

2.10.2 Avoid roads that are too narrow or by a canal/waterway without any fence/hedge.

2.10.3 Also avoid places where your wheels might get stuck, slip or not have traction.

2.10.4 Do not drive in a gale, at night or in rainy/snowy/foggy/misty weather. These conditions may cause your wheelchair to rust. (See Figure 2.2)

2.10.5 Do not drive in a S curve, do doughnuts or make sudden turns.

2.10.6 Do not take an escalator.

### **2.11 Mobile Phones and Other Electric Equipment**

2.11.1 Do not use a mobile phone or other wireless communication devices while driving. (See Section 3. EMI/RFI)

2.11.2 Do not charge the mobile phone or other electric devices from your wheelchair's batteries.

## 2.12 Ramps, Inclines and Drops

2.12.1 Do not drive onto a steep ramp. Refer to "Safe Slope" in Section 10.

SPECIFICATIONS for your wheelchair's maximum climbing angle.

2.11.2 When climbing up to an inclined road, please set the speed higher than the medium speed and drive carefully. (See Figure 2.3)

2.11.3 When going down an inclined road, set the speed to "1" and never use reverse.

2.12.4 Do not drive on a road with many bumps and holes close to each other, such as potholes or washboard roads. (See Figure 2.4)

2.12.5 Do not make sudden turns when driving on gravel roads or ramps.

2.12.6 The maximum surmountable obstacle height is 5cm for your wheelchair. Exceeding this obstacle height will damage your wheelchair and void your warranty. (See Figure 2.5)

2.12.7 When negotiating an obstacle slow down, put your seat into the full upright position and approach it head on (perpendicular).

2.12.8 Just before the obstacle, speed up until the entire wheelchair has conquered the obstacle. Negotiating an obstacle at an angle may cause your wheelchair to tip over. Don't do it!

2.12.9 When climbing down a curb, slow down just before you get to it and only speed up after the entire wheelchair has lowered to the road.

2.12.10 Again, descending obstacles should be done perpendicularly. (See Figure 2.6)

2.12.11 Karma does not design wheelchairs to take jumps over or off obstacles. Doing so will void your warranty.



### WARNING

- Do not set the wheelchair in freewheel mode when on an incline or decline.
- If you breakdown on railroad tracks, first, check for an oncoming train. If a train is coming, get out of its way immediately! If no train is coming, set to freewheel mode and push the wheelchair off the tracks.



## 2.13 Maximum User Weight Limit

2.13.1 Refer to "Max. User Weight" in Section 10. SPECIFICATIONS.

2.13.2 Loading exceeding maximum capacity can damage your wheelchair and cause malfunctions yielding a safety hazard. The warranty does not cover damage caused by improper operation of the wheelchair.



(Figure 2.1)



(Figure 2.2)



(Figure 2.3)



(Figure 2.4)



(Figure 2.5)



(Figure 2.6)

## 2.14 Service life

2.14.1 The expected service life of the product is **five years**, presuming that the product is used daily in accordance with the safety operation instructions, inspection and maintenance instructions, and intended use, which described in this manual.

## 2.15 Labeling

2.15.1 Please carefully read all the labeling on the wheelchair before driving it.  
Do not remove them. Protect them for future reference.

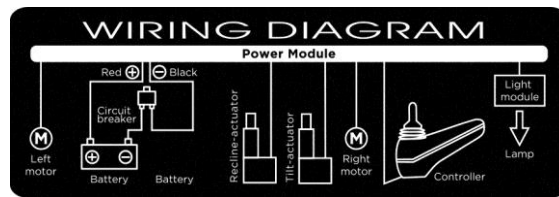

(LFP)

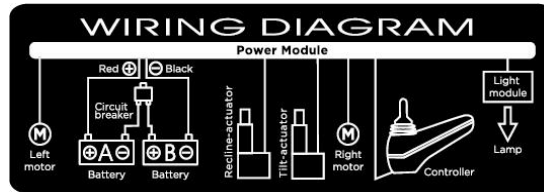

(PbAc)



<b>Karma Medical Products Co., Ltd.</b>		
2363, Sec. 2 University Rd., Min-Hsiung, Chia-Yi 621, Taiwan		
<b>TYPE</b>	<b>Saber GT</b> <input type="checkbox"/> T <input type="checkbox"/> TR	
	(KP-45.6)	
<b>V max.</b>	<b>12 km/h</b>	<b>max.</b> <b>10°</b>
<b>KG</b>	<b>135 kg</b>	<b>SN:</b> <input type="text"/>

### 3. EMI/RFI

This section provides the user with basic information about the problems with EMI, known sources of EMI and protective measures either to reduce the possibility of exposure or to minimize the degree of exposure. This section also shows some conditions in which unexpected or erratic wheelchair movements may occur.



#### CAUTION

- **It is very important that you read this information regarding the possible effects of electromagnetic interference on your powered KARMA wheelchair.**

### 3.1 Electromagnetic Interference from Radio Wave Sources

3.1.1 Powered vehicles may be susceptible to electromagnetic interference (EMI), which is interfering electromagnetic energy (EM) emitted from sources such as radio stations (Radio Frequency Interference), TV stations, amateur radio (HAM) transmitters, two-way radios, and cellular phones. The interference (from radio wave sources) can cause the powered vehicle to release its brakes, move by itself, or move in unintended directions. It can also permanently damage the powered vehicle's control system. The intensity of the interfering EM energy can be measured in volts per meter (V/m). Each powered vehicle can resist EMI up to a certain intensity. This amount of resistance is called its immunity level. The higher the immunity level, the greater the protection. At this time, current technology is capable of achieving at least a 20 V/m immunity level, which would provide useful protection from the more common sources of radiated EMI. This powered vehicle model, with no further modification, has an immunity level of 20 V/m without any accessories.

3.1.2 There are a number of sources of relatively intense electromagnetic fields in our everyday environment. Some of these sources are obvious and easy to avoid. Others are not apparent and exposure could be unavoidable. However, we believe that by following the warnings listed below, your risk to EMI can be greatly minimized.

## 3.2 The sources of radiated EMI can be broadly classified into three types.

3.2.1 Hand-held portable transceivers (transmitter-receivers) with the antenna mounted directly on the transmitting unit, such as citizens band (CB) radios, walkie-talkies, security and fire or police transceivers, cellular telephones and other personal communication devices;

### NOTE:

Some cellular telephones or similar devices transmit signals while they are ON, even though they are not in use.

3.2.2 Medium-range mobile transceivers used in police cars, fire trucks, ambulances and taxis usually having the antenna mounted on the outside of the vehicle; and

3.2.3 Long-range transmitters and transceivers, such as commercial broadcast transmitters (radio and TV broadcast antenna towers) and amateur (HAM) radios.

### NOTE:

Other types of hand-held devices (cordless phones, laptop computers, AM/FM radios, TV sets, CD players, cassette players, and small appliances such as electric shavers and hair dryers, et cetera) so far as we know, are not likely to cause EMI problems.

## 3.3 Powered Vehicle Electromagnetic Interference (EMI)

Because EM energy rapidly becomes more intense as one moves closer to the transmitting antenna (source), the EM fields from hand-held radio wave sources (transceivers) are of special concern. It is possible to unintentionally bring high levels of EM energy too close to the powered vehicle's control system while using these devices. This can affect your powered vehicle's movement and braking. Therefore, the warnings listed below are recommended to prevent possible interference with the control system of the powered vehicle.

### 3.4 Warnings

Electromagnetic interference (EMI) from sources such as radio and TV stations, amateur radio (HAM) transmitters, two-way radios and cellular phones can affect powered vehicles and motorized wheelchairs.

Following the warnings listed below should reduce the chance of unintended brake release or powered vehicle movement which could result in serious injury.

3.4.1 Do not operate hand-held transceivers-receivers such as citizens band (CB) radios or turn ON personal communication devices such as cellular phones, while the powered vehicle is turned ON.

3.4.2 Be aware of nearby transmitters, such as radio or TV stations, and try to stay away from them.

3.4.3 If unintended movement or brake release occurs, turn the powered vehicle OFF as soon as it is safe.



#### CAUTION

● **Some stores may have automatic (sensor) doors and alarm systems set at certain frequencies that might affect your powered wheelchair.**

3.4.4 Be aware that adding accessories/components or modifying the powered vehicle may make it more susceptible to EMI. There is no easy way to evaluate their effect on the overall immunity of the powered vehicle.

3.4.5 Report all incidents of unintended movement or brake release to your powered vehicle dealer or KARMA, and note whether there was a source of EMI nearby.

## 4. PARTS

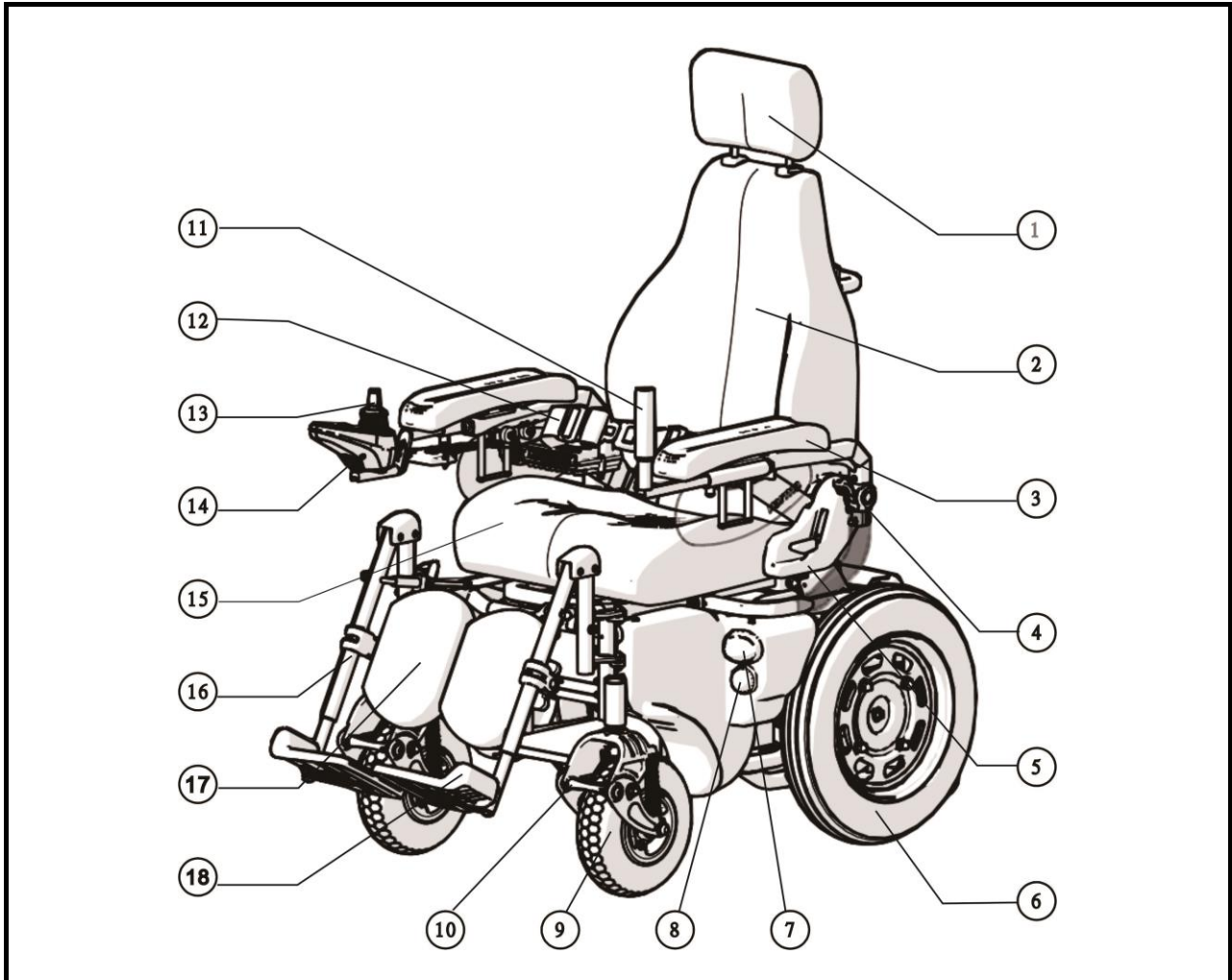

- |                       |                       |
|-----------------------|-----------------------|
| 1. Headrest           | 10. Front Fork        |
| 2. Backrest           | 11. Handle            |
| 3. Armrest            | 12. Pelvic Belt       |
| 4. Armrest Lock Joint | 13. Joystick          |
| 5. Recline Lever      | 14. Charging Socket   |
| 6. Drive Wheel        | 15. Seat              |
| 7. Headlight          | 16. Footrest Assembly |
| 8. Turn Signal        | 17. PU Calf Pad       |
| 9. Caster             | 18. Footplate         |

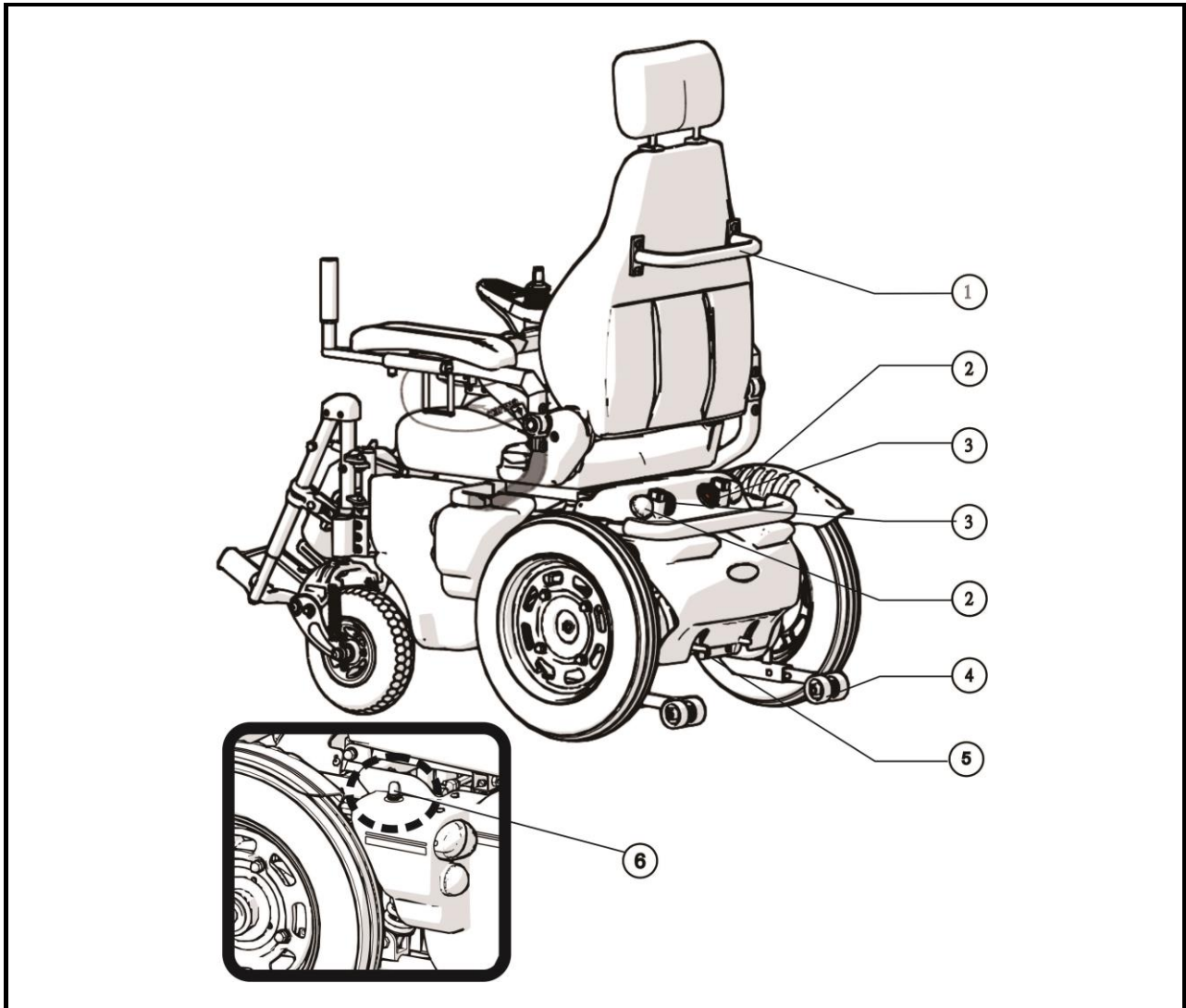

- |                    |                    |
|--------------------|--------------------|
| 1. Push Handle Bar | 4. Anti-tipper     |
| 2. Turn Signals    | 5. Freewheel Lever |
| 3. Taillights      | 6. Circuit Breaker |



The backrest can be reclined to a maximum angle of 155 degree.

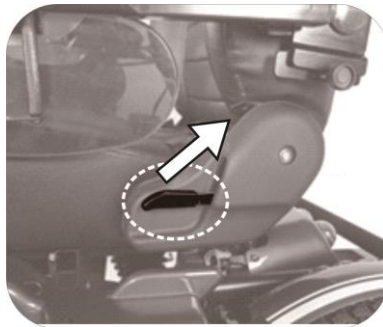

Adjust the reclining angle of backrest by pulling the lever at the left side of the seat.



Tilt Actuator

## 5. OPERATION

### VR2 Joystick Controller

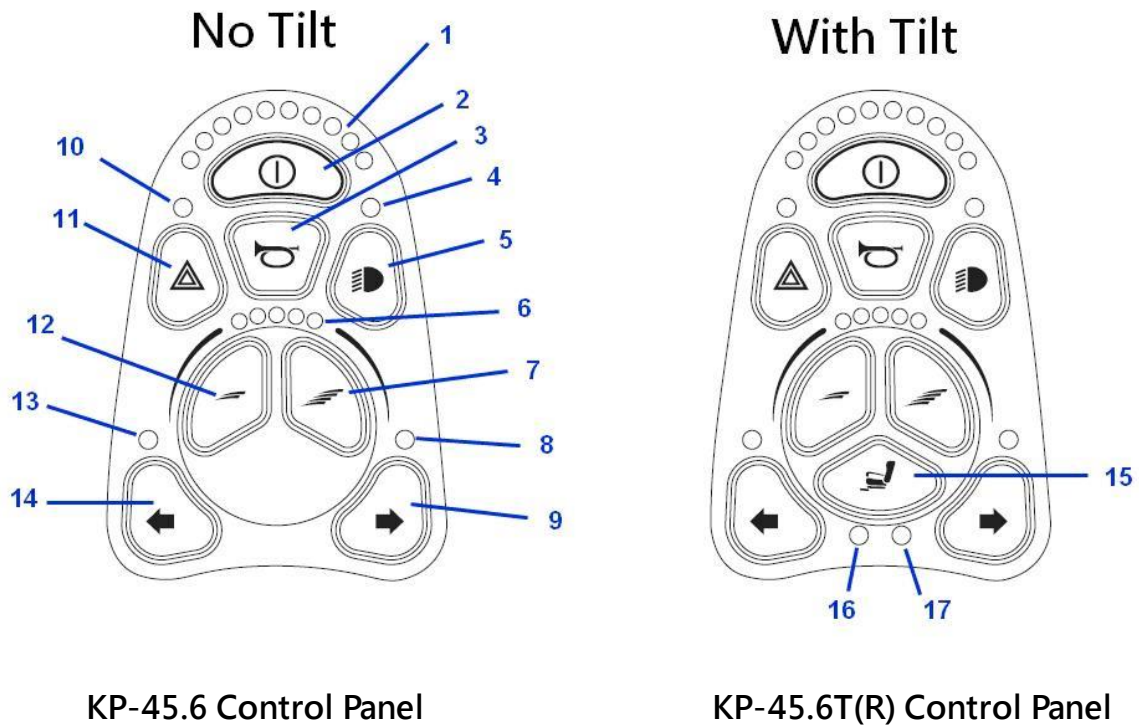

(Figure 5.1)

1. Battery Gauge	5. Headlight / Taillight Button	10. Hazards Indicator	15. Seat Function Button
2. ON/OFF Button	6. Speed Indicator	11. Hazards Button	16. Tilt Indicator
3. Horn Button	7. Speed Increase Button	12. Speed Decrease Button	17. Recline Indicator
4. Headlight / Taillight Indicator	8. Right Indicator	13. Left Indicator	
	9. Right light Button	14. Left light Button	



## 5.1 How to Operate Your wheelchair

Note: Before using this wheelchair, make sure that the following parts are assembled as below. In the cases that the following parts are not assembled, do complete the assembly referring to the figures. Should you have any question about the assembly, please contact your authorized Karma dealer.

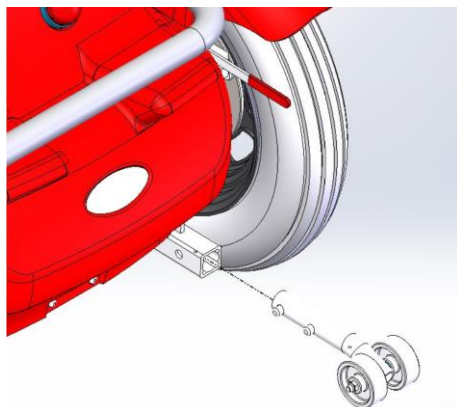

### -Anti-Tippers

Complete the assembly of anti-tippers according to the figure at the left.

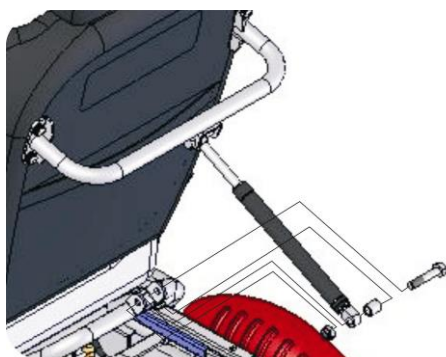

### -Gas Strut

Complete the assembly of the gas strut according to the figure at the left.



### -Actuator

Before use the wheelchair please assemble the actuator according to the figure at the left.

Do not operate this equipment without first reading and understanding this manual. Do not change the parameters of the controller which has been preset in the factory. If it is necessary to modify the parameters, contact Karma technical personnel to modify it. This will ensure the safety of the user and the modification that is complied with the relative regulations. Do not change or modify any electric circuit because this can cause injury or damage.

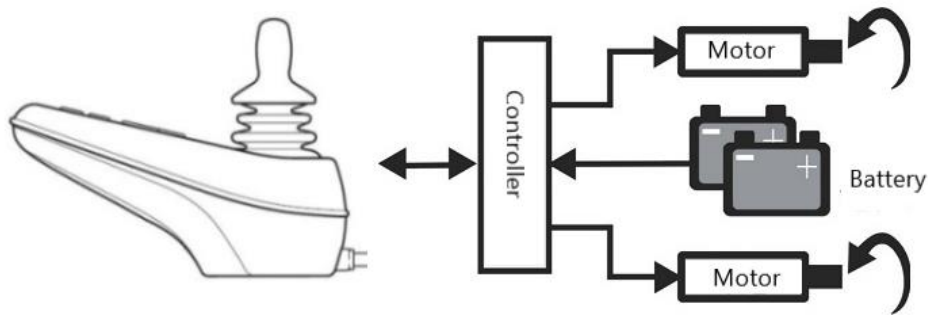

Circuit Diagram

VR2 Controller can be installed in the wheelchair. Please refer to relative control panel for the operation of the wheelchair.

#### 5.1.1 Power ON/OFF

5.1.1.1 Press the power button. Be sure not to touch the joystick while turning on the controller. Your battery & diagnostics indicator should light up. (See Figure 5.1, 5.2)

5.1.1.2 If the joystick is not in the neutral position when the wheelchair is powered on, the system will inhibit the movement of the wheelchair and the battery indicator will flash. Move the joystick to the neutral position and the operation of the wheelchair will come to normal.



#### CAUTION

- For VR2 controller, the battery indicator might be lower than the actual value if the wheelchair is powered off and on immediately. The controller will recalculate it when the wheelchair is driven for a short distance. The battery indicator will show the actual value, then.

#### 5.1.2 Locking / Unlocking the Wheelchair

##### 5.1.2.1 VR2 Controller

The VR2 control system can be locked to prevent unauthorized use. The locking method is via a sequence of key presses and joystick movements, as detailed below.

To lock the wheelchair.

5.1.2.1.1. While the control system is switched on, depress and hold the

on/off button.

5.1.2.1.2. After 1 second the control system will beep. Now release the on/off button.

5.1.2.1.3. Deflect the joystick forwards until the control system beeps.

5.1.2.1.4. Deflect the joystick in reverse until the control system beeps.

5.1.2.1.5. Release the joystick, there will be a long beep.

5.1.2.1.6. The wheelchair is now locked.

To unlock the wheelchair.

5.1.2.1.7. Use the on/off button to switch the control system on. The maximum speed / profile indicator will be rippling up and down.

5.1.2.1.8. Deflect the joystick forwards until the control system beeps.

5.1.2.1.9. Deflect the joystick in reverse until the control system beeps.

5.1.2.1.10. Release the joystick, there will be a long beep.

5.1.2.1.11. The wheelchair is now unlocked.

## 5.1.2 Adjusting the Driving Speed

5.1.2.1 The user can adjust the wheelchair's top speed to suit their preferences and environment. The currently selected top speed is shown on the Speedometer and can be adjusted using the "Increase Speed" and "Decrease Speed" buttons. In the "5 speed" mode pressing the Increase Speed and Decrease Speed buttons steps between one of 5 top speeds 20% to 100%. I

5.1.2.2 Please slow down before you get used to control your powered wheelchair.

5.1.2.3 Please slow down your speed when indoor.



### CAUTION

- Please fasten the pelvic belt whenever the user is sitting on the wheelchair.

## 5.1.3 Driving Speed

The speed indicator will show the selected speed.

## 5.1.4 To Stop

5.1.4.1 This wheelchair is equipped with electromagnetic brakes.

5.1.4.2 Release the joystick and the electromagnetic brake will stop the

vehicle. The sound of click shows the brakes are acted.

5.1.4.3 Move the joystick will release the brake.

5.1.4.4 To check whether the brake works properly, turn on the power and move the joystick. The brake shall be released when the joystick is moved.

5.1.4.5 When the joystick is back to the neutral position, the brake will be acted.



#### CAUTION

- **The stopping distance will vary with your forward/reverse speed. Therefore, please gradually slow down and come to a complete stop well before any obstacles or danger.**
- **To park the wheelchair, be sure to park on flat ground and then turn the power to OFF.**
- **NEVER use the freewheel mode when going down an incline.**
- **The electromagnetic brake won't function in freewheel mode.**

5.1.5 Turn Signal (Indicator Light)

The signal light will flash if you press the rights or left indicator button.

Turn off the signal light by pressing the button again.

5.1.6 Headlights/Taillights

5.1.6.1 To turn the Headlight/Taillight on, press the Headlight/Taillight Button. Press the Headlight Button again to turn the headlight/taillight off.

5.1.7 Warning Signal (Hazards Light)

5.1.7.1 To turn the Hazards light on, press the Hazards Button. Press the Hazards button again to turn the hazards function off.



#### CAUTION

- **Turn off the lights when not in use to save battery power.**

5.1.8 Horn Button

The horn will sound for as long as the button is pressed.

5.1.9 Battery Gauge

5.1.9.1 The Battery Gauge is used to indicate power on and provides an estimate of the remaining battery capacity. Any green LEDs lit indicate well-charged batteries. If only amber and red LEDs are lit,

the batteries are moderately charged. Recharge before undertaking a long trip. If only red LEDs are lit, the batteries are running out of charge. Recharge as soon as possible.

#### 5.1.10 Tilt and Reclining Operation

5.1.10.1 KP-45.6T: Powered Tilt + Manual Reclining

5.1.10.2 KP-45.6TR: Powered Tilt + Powered Reclining

5.1.10.3 T: Powered Tilt (Seat Function 1)

5.1.10.4 R: Powered Reclining (Seat Function 2)

5.1.11. The maximum tilting degree is 38°, range from 9°-47°. The maximum reclining angle depends on the type of model. Please refer to the specifications. The maximum backrest angle for powered reclining and tilting is 55° (Tilting: 38°, Reclining: 27°)

#### Manual Reclining (KP-45.6)

5.1.10.1. To adjust the backrest angle, lift up on the seat recline lever on the side of the driver's seat.

5.1.11.2. Leaning forwards or backwards until the desired angle is achieved. Release the lever.

#### VR2 Controller (KP-45.6T&TR)

5.1.11.3. Depressing the actuator button will enter actuator adjustment mode. Depressing the button once illuminates the LEFT LED, and deflection of the joystick forwards or backwards will adjust the actuator connected to that channel. Selection between the two actuators is achieved by deflecting the joystick to the left and right. As the actuator selected changes then so will the LED, which illuminates. LEFT for actuator 1 and RIGHT for actuator 2.

5.1.11.4. To re-enter drive mode depress the actuator button again or depress either speed button



#### CAUTION

- The speed will be reduced to half while the seat is tilted within 15°. And the powered wheelchair cannot be driven while the seat is tilted over 15°
- When the seat is tilted or reclined, do not drive on any slope. Always keep the backrest of your seat in an upright position before driving on a slope. That is, when the backrest is tilted, do not drive it on a slope. Otherwise, the wheelchair could be tipped, and cause injury.



## CAUTION

- Do not put fingers or clothes under the seat or backrest while seat functions are operated.
- Do not move the wheelchair while the seat tilted or reclining functions are operated over the 110 degree.

### 5.1.12 Manual Reclining Operation (KP-45.6T)

5.1.12.1. Adjust the backrest angle by lifting up the reclining lever on the seat side. And release the lever when you have set the angle.

5.1.12.2. Tilt the seat back to the normal position before reclining the backrest.



## CAUTION

- For the models of this wheelchair that has the function of manual reclining. Note that the gas strut is filled with high pressure gas. Avoid the things as follows:
  - Do not operate it when the ambient temperature is higher than 60°C or in the fire.
  - Do not tow the wheelchair at the gas strut.
  - Do not hit the gas strut by other object.



## SUGGESTION

- It is recommended to lubricate tilt and recline actuator every one or 2 months periodically.



## SUGGESTION

- Tilt the chair back to its balance point before you manually adjust the backrest.
- It is recommended that you charge the batteries immediately when the battery indicator shows only three or less red lines.
- After charging or replacing new batteries, drive the wheelchair for 2-3 minutes to make sure the batteries are fully charged before going on a long journey.
- In wintertime, the batteries may respond slowly and the drive range may also be reduced. You must store your wheelchair indoors above freezing temperatures.

- When driving on an incline, the battery indicator light might move up and down. This is normal.
- Even if the batteries are used properly their capacity will decay over time, thereby reducing the drive range (maximum distance traveled per full charge). Thus, when the drive range becomes about 50% of what brand new batteries would offer, it's time to replace them with new batteries. Otherwise, the batteries may die unexpectedly leaving you in a possibly precarious situation.
- The drive range will be shortened when driving frequently on slopes or uneven ground, as this consumes more battery power.

#### 5.1.13 Freewheel Lever

This wheelchair is equipped with a freewheel lever. It allows the user to manually pushing the wheelchair if required. See Figure 5.3 for operation instructions.

##### 5.1.13.1 To Select Neutral from the Engaged Position

5.1.13.1.1 Push the freewheel lever downwards located under the rear casing. The wheelchair will now roll freely.

##### 5.1.13.2 To Engage the Motors from the Neutral Position

5.1.13.2.1 Simply pull the freewheel lever upwards. The Motor are engaged.



#### CAUTION

- Always ensure that the freewheel lever are engaged before using the wheelchair. (i.e. Before turning on controller)
- The freewheel lever can only be pushed downwards when the power of the controller is turned off.
- When the freewheel lever are neutral (no brakes), we suggest that there's one attendant for assistance.



(Figure 5.3)

#### 5.1.14 Tires

- The condition of the tires is affected by the way you drive and use your wheelchair.
- Inspecting Tire Tread: please check the tread depth regularly.
- Replace the tires when the tread depth is less than 0.5 mm.
- Please refer to the tires pressure specified on the tire walls correct pressure to maintain the tires at the correct pressure. Do not let anyone touch the wheels when the wheelchair is in motion to avoid pinch injury.



#### CAUTION

- Always ensure the tire pressure is within the specification.



## 5.2 How to Adjust Your wheelchair

### 5.2.1 Headrest Adjustment

5.2.1.1 To raise headrest, lift headrest up to desired position.

5.2.1.2 To lower headrest, push release button and lower headrest to desired position.

5.2.1.3 Headrest is locked in position when an audible "click" is heard. If the "click" cannot be heard, consult an authorized technician for safety. (Figure 5.7)



### WARNING

- When raising the headrest, never exceed the marked line to ensure safety.

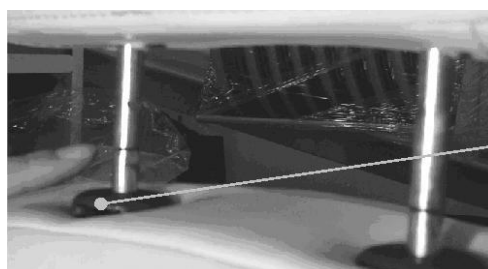

Headrest Lock  
Release Button

(Figure 5.7)

### 5.2.2 Footrests Adjustment

5.2.2.1 The footrest assemblies can be swung-away and detached. The footplates can also be flipped up.

5.2.2.2 To swing-away and/or detach the footrests, pull the swing-away lever inwards and the footrest will swing outwards. (See Figures 5.8) At this point you can lift the footrest assembly off of the mounting posts. The dome studs are the mounting posts for the elevating footrest assembly.

5.2.2.3 To attach the footrest assembly, set the two holes on the opposite end from the footplate over the dome studs and rotate the footrest assembly inward to lock it in place. Attach the other footrest in the same manner.

5.2.2.4 The footplates can be flipped-up to make transferring in and out of the wheelchair easier, though you can also swing-away the entire footrest when you transfer.

5.2.2.5 Your footplate length should be adjusted according to your calf

length. Go to your service provider for adjustment or use the Allen Wrench included in your KARMA Tool Kit to loosen the screws at the under the footplate. (See Figures 5.9) Then, adjust it to the desired length, and retighten the screws. (See Figures 5.10) Karma suggests that the distance between the lowest point of the footplate and the floor is at least 5 cm.



(Figure 5.8)



(Figure 5.9)



(Figure 5.10)



### CAUTION

- When adjusting the footrest or the footplates, the user's legs should be supported or kept safe from possible injury.

## 5.2.3 Armrest Adjustment

### Flip Back Armrest

5.2.3.1 By pressing Armrest Lock Joint lever, the armrest can be lifted backwards. (Figure 5-11, Figure 5-12)

5.2.3.2 Use the #4 Allen key to loosen the screws. Adjust the armrest height and re-tighten the screws. (Figure 5-13, Figure 5-14)

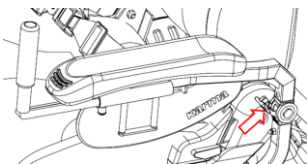

Figure 5.11

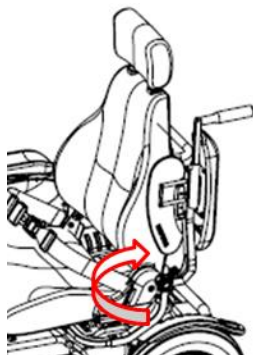

Figure 5.12

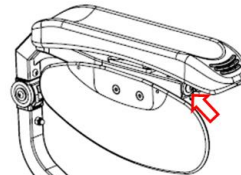

Figure 5.13

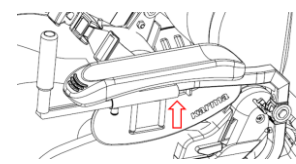

Figure 5.14

5.2.3.3 Use the Allen Key Wrench to loosen the screws. Remove the stopper A. Adjust the armrest forwards or backwards and re-tighten the screw. (Figure 5-15, Figure 5-16)

Note: If the armrest pad is adjusted to the backward position, use the longer screw (M8\*P1.25\*55L).

5.2.3.4 Loose the knob screw. (Figure 5-17) Lift the seat. (Figure 5-18). Loose screw A. Adjust the armrest inward or outward. (Figure 5-19) While adjusting the seat width, ensure to align the number marked on the armrest with the tube end of the frame tube. (Figure 5-20)

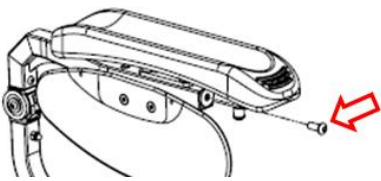

Figure 5.15

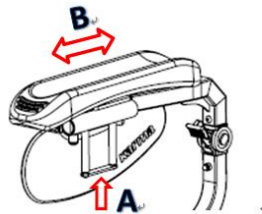

Figure 5.16



Figure 5.17

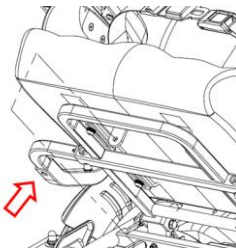

Figure 5.18

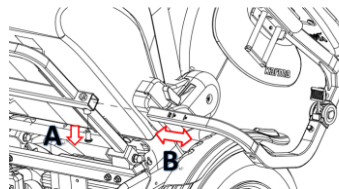

Figure 5.19

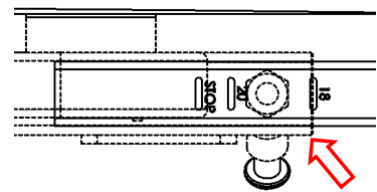

Figure 5.20

## 5.2.5 Driver's Seat Detachment

5.2.5.1 Detach the armrest which is equipped with the joystick controller. (See Figure 5.21) Leave its cabling connected to the lower body/electronics of the wheelchair.

5.2.5.2 Fold the driver's seat down/forward.

5.2.5.3 Loosen the knob bolt located under the front of the driver's seat. (See Figure 5.22)

5.2.5.4 Remove the rear casing. (See Figure 5.23)

5.2.5.5 Remove the screws of the seat base bracket. (M6\*25L x2) (See Figure 5.24)

5.2.5.6 Lift the driver's seat off of the lower body of the wheelchair. Lift the front of the seat first, followed by the rear of the seat. The seat detachment is completed. (See Figure 5.25)



## CAUTION

- Do not remove the driver's seat from the wheelchair without first detaching the controller from the armrest or detaching the controller with the armrest. KARMA is not responsible for damage to the cabling or connection points caused by trying to remove the seat while the controller is connected to the lower body of the wheelchair.



(Figure 5.21)



(Figure 5.22)

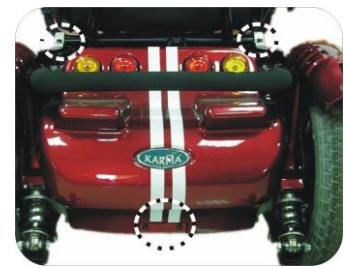

(Figure 5.23)



(Figure 5.24)



(Figure 5.25)

### 5.2.6 Driver's Seat Attachment

5.2.6.1 Place the rear of the seat into its receiving groove and then tilt the front of the seat forward into position.

5.2.6.2 Please reverse the steps specified in the above section 5.2.5 Driver's Seat Detachment to attach the driver's seat.



## CAUTION

- The seat release lever must be in the locked position for the controller to function. This safety sensor is designed to protect the user from having the seat detached while in use. An error code will also flash if the seat release lever is not in the proper position.

### 5.2.7 Moving the Seat Forwards or Backwards

5.2.7.1 Loosen the knob bolt under the front of the seat.

5.2.7.2 Tilt the seat back.

5.2.7.3. Loosen the four bolts under the driver's seat with the Allen Wrench included in your KARMA Tool Kit. (See Figure 5.26)

5.2.7.4 Slide the seat forwards or backwards to the desired position. The

total range of adjustment is 10 cm.

5.2.7.5 Re-tighten the bolts.

5.2.7.6 Tilt the seat down and relighted the knob bolt.

### 5.2.9 Anti-tippers

Use the tool supplied in your KARMA Tool Kit to attach the suspension anti-tippers. (See Figure 5.27)

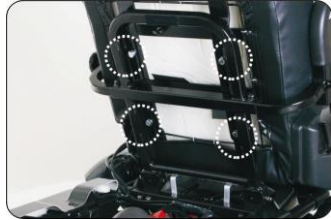

(Figure 5.27)



(Figure 5.28)



## CAUTION

● **Do not remove the anti-tippers on your wheelchair to prevent injury.**

### 5.2.10 Starting and Driving

5.2.10.1 Make sure the driver's seat is installed properly

5.2.10.2 Make sure the armrests have been returned to the proper position.

5.2.10.3 Turn the power ON. If necessary, turn on the headlights and taillights.

5.2.10.4 Check the battery indicator and make sure there is enough power for your trip(s). If you have any doubt about the remaining power, please charge the battery before you depart.

5.2.10.5 Set the speed dial to the proper level.

5.2.10.6 Be sure the controller is in good condition.

5.2.10.7 Make sure the electromagnetic brake is in good working order..

5.2.10.8 Always make sure that your surroundings are safe to operate the wheelchair.

### 5.2.11 Getting Into Your Wheelchair

5.2.11.1 Turn off the power.

5.2.11.2 Flip up the footplates and swing-away the footrests.

5.2.11.3 The user lowers the body and sits on the wheelchair gently.

5.2.11.4 Flip down the footplate. Adjust footplate length should according to your calf length if necessary.

5.2.11.5 Turn on the power.

## 5.2.12 Getting Out of Your Wheelchair

5.2.12.1 Ensure you have driven the wheelchair to the proper location.

5.2.11.2 Turn off the power..

5.2.11.3 Move the feet away from the footplates and flip up the footplates.

5.5.13 With hands on the armrests, the person should bend slightly forward, to bring the body weight to the front of the seat, and then with both feet firmly on the ground and one foot behind the other, push up into the upright position.



### CAUTION

- Do not turn the power OFF while driving, as this will lead to an abrupt stop and possible injury.
- Do not set the speed dial on high while driving indoors.
- Do not adjust the speed dial while driving. A sudden change to the highest speed may endanger you and cause failure to your wheelchair.
- Do not place magnetic devices near the controller, as this may affect the operation of your wheelchair.
- Be careful while driving in heavy traffic and crowded areas.
- While reversing the vehicle be aware of people and objects behind you.

## 6. BATTERIES AND CHARGER

### 6.1 Charging the Batteries

Before you attempt charging, ensure you read and understand the instruction manual supplied with the battery charger, and you choose the correct input voltage for battery charger.

### 6.2 Charge your batteries if any of the following conditions occur

6.2.1 If you have used your wheelchair for more than an hour continuously. We recommend you charge battery after your use.

6.2.2 You've used more than one fourth of the total charge.

6.2.3 When you haven't used the wheelchair for more than two weeks.

6.2.4 If the current charge is not enough to reach your final destination.



#### WARNING

- If the battery is not charged completely, the lifetime of it may be reduced.
- If the accumulative travel distance is frequently more than half of the distance range before recharging the battery, the lifetime of the battery may be reduced.
- The charger shall not be connected to an extending power cord which is also connected to other electric devices.
- The charger of PbAc battery is different from that of LFP battery. Use the correct charger for charging the battery.



#### SUGGESTION

- Do not disconnect the charger cord if the charging is not completed. The battery life will be seriously shortened or decayed if the batteries are repeatedly used without being fully charged. Therefore, be sure to always charge the batteries fully.
- Always complete the charging by letting the charge LED light turn green. NEVER stop charging before it is complete.
- When finished charging, disconnect the charger plug from the charging socket as soon as possible. Even when the charger is turned OFF, the electric power will slowly discharge if the cord is not disconnected. DO NOT leave the charger ON connected to the wheelchair for more than 24 hours.
- Charging time depends on the surrounding temperature; it takes longer in the winter.



## CAUTION

- Please follow the guidelines below to avoid accidents while charging.
- Be sure to only use a KARMA approved battery charger and charge the battery completely every time. The battery can be damaged if a non-genuine charger is used.
- Never disassemble or modify the charger. This will void the warranty.
- Please charge in a well-ventilated area where the battery is not directly exposed to sunlight. Do not charge the battery under rainfall, in morning dew or in an area where the humidity is high.
- Do not cover the wheelchair with any waterproof cloth or other objects while charging. Don't charge in temperatures less than  $-10^{\circ}\text{C}$  ( $14^{\circ}\text{F}$ ) or higher than  $50^{\circ}\text{C}$  ( $122^{\circ}\text{F}$ ) as the charger may not work well and the battery may become damaged.
- The charger is not guaranteed to be water resistant.
- Valve Regulated Lead-Acid batteries do not have a memory function like cell phone batteries have. Please get in the habit of recharging your VRLA batteries frequently.
- New batteries **MUST** be fully charged prior to initial use of the powered wheelchair.
- Always charge new batteries before initial use or battery life will be reduced.
- As a general rule, recharge batteries as frequently as possible to assure the longest possible life and to minimize required charging time. Plan to recharge them when use of the powered wheelchair is not anticipated.



## WARNING

- Keep your wheelchair away from flammable objects while charging, as it may lead to fire or explosion of the battery.
- Since the battery may produce hydrogen, do not smoke while charging and charge in a well-ventilated area.
- Never connect or disconnect the plug (cord) with wet hands or if the plug (cord) is wet to avoid possible electric shock.
- Never attempt to recharge the batteries by attaching cables directly to the battery terminals or clamps. **DO NOT** jump start your wheelchair!
- **DO NOT** attempt to recharge the batteries while the powered wheelchair is in operation.



## 6.3 Charger



### CAUTION

- Before charging, make sure to set the 115V ↔ 230V switch to match the local AC voltage. If the switch is improperly set to a lower or higher voltage position, it will cause damage to the charger, and, Change the 115V ↔ 230V switch settings only when charger is disconnected from AC line voltage.



### CAUTION

- The charger of PbAc battery is different from that of LFP battery. Use the correct charger for charging the battery.

### Lead-Acid battery

The charger of PbAc battery is different from that of LFP battery. Use the correct charger for charging the battery. The battery charger supplied by Karma is for indoor use only. It must be protected from moisture and external heat source.

### Lead-Acid battery (PbAc Battery)

- 6.3.1. Turn the wheelchair OFF and remove the key.
- 6.3.2. Connect the charger's cord to a power outlet.
- 6.3.3. Connect the charger's plug to the charging socket.
- 6.3.4. Turn on the charger by pressing the power switch.
- 6.3.5. The charger's LED will light up as soon as the charging starts. The charging time is at least 8 to 12 hours, depending on the status of the batteries and temperature.
- 6.3.6. The orange LED will change to green when the charging is completed.
- 6.3.7. Turn off the charger, disconnect the cord and pull out the round plug from charging socket.
- 6.3.8. For more detail information of the charger, please refer to the operation manual of the charger.
- 6.3.9. The charger is suitable for batteries with the specifications of 12V 50AH to 12V 75AH.

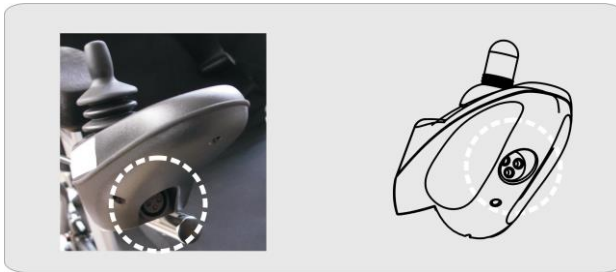

(Figure 6.1)



## LFP battery

6.3.10. Connect the charger's cord to a power outlet.

6.3.11. Connect the charger's plug to the battery. Make sure the direction of the plug is correct.

6.3.12. Turn on the charger by pressing the power switch. The charger's red LED will light up if the AC power is normal.

6.3.13. The charger's orange LED will light up soon as the charging starts.

6.3.14. The orange LED will change to green when the charging is completed.

The digital display will show END. The charger will stop charging automatically and turn off both voltage and current output.

6.3.15. For your safety, turn off the charger or disconnect the charger's cord from the power outlet before taking the battery out.



(Figure 6.2)



### CAUTION

- Before charging, make sure to set the 115V ↔ 230V switch to match the local AC voltage. If the switch is improperly set to a lower or higher voltage position, it will cause damage to the charger, and, Change the 115V ↔ 230V switch settings only when charger is disconnected from AC line voltage.



## WARNING

- The fan inside the charger will start to work when you turn on the charger. (for 8A charger will start to work as temperature is over 50°C and stop running under 50°C) If you find that the fan does not function properly, DO NOT use the charger. Otherwise, the charger may overheat and start a fire.

## 6.4 Batteries

The wheelchair can be equipped with PbAc battery or LFP battery. It depends on the specifications of the wheelchair.

6.4.1. Do not expose the batteries to temperatures below -10°C(14°F) or above 50°C(122°F) when charging or storing the vehicle.

6.4.2. Exceeding the specified temperature range can lead to either freezing or overheating of the batteries. This will damage the batteries and shorten their lives



## WARNING

- Do not open the battery seal cap at any time and keep your wheelchair away from flammable objects while charging, as it may lead to fire or explosion of the battery.
- After ANY adjustments, repair or service and BEFORE use, make sure that all hardware is tightened securely. Otherwise, injury or damage may occur.
- When removing/installing batteries, keep all foreign objects, especially metal, away from battery terminals.



## CAUTION

- Place the powered wheelchair in a well-ventilated area where work can be performed without risking damage to carpeting or floor covering.
- Failure to use the correct battery size and/or voltage may cause damage to the powered wheelchair and give unsatisfactory performance. For replacement of batteries, please contact your local KARMA supplier/dealer in order to ensure that the new batteries are correctly be used.

NOTE: Charge batteries daily. It is critical not to let them run low at any time.

NOTE: Karma recommends that both batteries be replaced if one battery is defective.



## WARNING

- NEVER allow any of your tools and/or battery cables to contact BOTH terminal posts at the same time. An electrical short may occur and injury or damage may occur.



## CAUTION

- When tightening the clamps, always use a box or crescent wrench. Pliers will round off (strip) the nuts. NEVER wiggle the terminal when tightening, as the battery may be damaged.

## 6.5 Cleaning the Batteries

If a battery is contaminated by dirty water, battery acid, dust or other soil, the battery will discharge quickly. Therefore, please follow the following steps to clean the battery:

6.5.1 Turn the power OFF.

6.5.2 Remove the driver's seat.

6.5.3 Use a clean cloth to wipe off the soiled area.

6.5.4 Take out the battery.

6.5.5 Clean the battery with a clean cloth.

6.5.6 Examine the battery clamps/terminals for corrosion, if the terminal is covered by white powder, please stop using the battery due to it indicates that there's possible leakage of the battery. Please replace the batteries.

6.5.7 Clean the terminals and inside of the battery clamps by using a battery cleaning tool, wire brush or medium grade sandpaper. Upon completion, these areas should be shiny, not dull.

6.5.8 Carefully dust off all metal particles.



## SUGGESTION

- If necessary, ask for help from your KARMA wheelchair dealer for cleaning and replacing the batteries.
- Do not use the battery to charge telecom equipment or other items.
- Battery capacity will vary with outside conditions; the maximum drive range will decrease in the winter. If the vehicle is not going to be used for a long time, please remember to charge the batteries at least once every two weeks.
- Replace both batteries simultaneously.



## WARNING

- Do NOT allow conductive material such as a wrench to join these two battery terminals. This will result in a short that can cause burns to you and damage the battery.
- Most batteries are not sold with instructions. However, warnings are frequently noted on top of the batteries. Read them carefully.
- Do NOT allow the liquid in the battery to come in contact with skin, clothes or other items. It is a form of acid and may cause harmful or damaging burns. Should the liquid come into contact with skin, rinse the area immediately and thoroughly with cool water. If liquid comes into contact with eyes, flush eyes immediately and seek medical attention as soon as possible.
- The use of rubber gloves and chemical goggles are recommended when working with batteries.
- NEVER smoke or strike a match near batteries.
- Replace the batteries IMMEDIATELY if there are any cracks or leaks.



## WARNING

- There are many risks involved with improper disposal of batteries, whether damaged or not. Batteries may contain heavy metals and be considered hazardous waste.
- Many regions around the world now strictly enforce laws to help protect our environment. By not disposing of batteries properly, you may be liable for fines from your local through national government.
- By not recycling batteries, they end up in landfills that are already low on space. From these landfills, lead and other chemicals may leach into streams and rivers destroying ecosystems and poisoning local water resources.
- Improper disposal of batteries may also cause injury to unsuspecting others that come in contact with them. If you come in contact with fluids or corroded powder from a battery, rinse with water and contact a physician if necessary. If contact with eyes occurs, rinse for 15 minutes and then visit a physician.
- Incinerating or burning a battery will cause it to explode!
- Please see the end of Section 11. Cleaning & Recycling for more information.

## 7. INSPECTION AND MAINTENANCE

### 7.1 Daily Check

Check the following items before driving. If you find anything abnormal, visit your KARMA wheelchair dealer for further inspection before using it.

Item	Inspection Content
Joystick Controller	<p>Is the joystick loose and/or making noise?</p> <p>Can the joystick be turned left and right smoothly?</p> <p>Can the speed buttons be adjusted freely and do they function well?</p> <p>Does the wheelchair stop when the joystick is released completely?</p> <p>Does it light up when the power is ON?</p> <p>Is there enough power for your trip?</p> <p>Does the horn work well?</p>
Motor	<p>Is there any abnormal noise?</p> <p>Does the electromagnetic brake work properly?</p>
Freewheel Mode	Do the freewheel levers work properly?
Driver's Seat	<p>Does the driver's seat recline?</p> <p>Do the seat angle adjustment knobs or buttons work properly?</p> <p>Does the surface of the seat remain or break?</p>
Tires	<p>Are there any cracks or other damage to the tires?</p> <p>Check the tire tread depth and air pressure.</p>
Other	Is there any abnormal motor noise?



#### CAUTION

- Visit a KARMA wheelchair dealer for inspection and maintenance if you find anything abnormal.

### 7.2 Regular Maintenance Record

In order to ensure that your wheelchair is in good condition, please contact Karma authorized dealers regularly and make further wheelchair inspection and maintenance records. We recommend that you inspect and maintain your wheelchair **every six months**. A maintenance/service fee may apply.



## SUGGESTION

- Even if you don't use the wheelchair for a long time, the wheelchair should still be maintained regularly.
- You should clean your wheelchair, inside and out, regularly to keep it beautiful and safe.

I - Inspection

A - Adjustment

Δ - Repair

3 - Replacement

T - Tightening

L - Add Oil

Item/Period		1 month	6 month	12 month	18 month	24 month	30 month
Joystick Control Unit		I	I	I	I	I/3	I/3
Power Module			I	I	I	I/3	I/3
Controller Buttons			I	I	I	I/3	I/3
Connection to the Electrical System		I		I		I	I/A
Motor	Operation and Noise		I	I	I/A	I/A	I/3
	Electromagnetic Brakes	I	I	I	I	I/3	I/3
	Connection to the Electrical System			I		I	
Batteries	Loose or Corroded Terminals			I		I	
	Connection to the Electrical System			I		I	
	Damage to the Electrical Cord/Cable			I		I	
Charger	Charging Function and LED Light	I	I	I	I/Δ	I/Δ	I/Δ
	Socket, Plug and Cords	I		I		I	
	Fan Functions Properly (if applicable)	I		I		I/Δ	
Driver's Seat	Recline Function				I/L		I/L
Tires	Cracks/Surface Damage	I/3	I/3	I/3	I/3	I/3	I/3
	Tread Depth	I	I	I/3	I	I/3	I
	Abnormal Wear Pattern	I		I/3		I/3	
Wheel	Tightness of Bolts and Nuts		I		T		T

Item/Period		1 month	6 month	12 month	18 month	24 month	30 month
Rim	Wear or Deformation Around Tires	I		I/3		I/3	

### 7.3 Tires

7.3.1 The condition of the tires is affected by the way you drive and use your wheelchair.

7.3.2 Inspecting Tire Tread: please check the tread depth regularly. Replace the tires when the tread depth is less than 1.0mm.



#### CAUTION

- When the tread depth is below 1.0 mm, the tire does not have good traction. This may lead to vehicle slippage and makes braking distances much longer. Thus, go to your Karma dealer to replace the tire as soon as possible if it has less than 1.0 mm tread depth.
- The tire pressure must be kept at between 40-50 PSI (approx. 1.8 kg/cm or 2.75~3.45 bar=275-345 kPa) for the best drive range (maximum distance travelled per charge) and usage/ handling.

### 7.4 General Maintenance

7.4.1 You must maintain the vehicle more frequently if you drive on grass, sand or gravel roads often.

7.4.2 Do not use water, oil or other chemical solutions to clean your wheelchair. Be sure NOT to spray the vehicle with water, as not to damage the electronic components and PCB circuit board.

7.4.3 Please clean the vehicle by wiping it with either a dry or moist cloth.

7.4.5 Please take the vehicle to an authorized KARMA wheelchair dealer for repairs and adjustments. Improper adjustments could lead to wheelchair malfunction or an accident.

7.4.6 Please use a soft and dry cloth to keep your wheelchair clean. Use moderate or mild detergent to clean the wheelchair, if necessary.





## CAUTION

- Before performing any maintenance, be sure to turn the power OFF and unplug the charger if connected.
- DO NOT over-tighten hardware. This could cause damage to the frame and hardware.



## SUGGESTION

- Do not directly spray water on your wheelchair to wash it, as this could lead to a malfunction in the electric system.
- Do not use gasoline, solvents or other abrasive solutions; the casing may become deformed or damaged.



## WARNING

- After ANY adjustments, repair or service and BEFORE use, make sure that all hardware is tightened securely; otherwise injury or damage may occur.

## 7.5 Suggested Maintenance Procedures

7.5.1 Before using the powered wheelchair, make sure all nuts and bolts are tight.

7.5.2 Check all parts for damage or wear and have a qualified technician replace it if necessary.

7.5.3 Check all parts for proper adjustment.

7.5.4 Ensure that the batteries are properly maintained and charged as required.

7.5.5 Inspect brake for proper operation.

7.5.6 The wheels and tires should be checked periodically for cracks and wear, and should be replaced by a qualified technician.

7.5.7 Regularly check for loose nuts and/or bolts in the front and drive wheels. If loose, have them adjusted by a qualified technician.

7.5.8 Clean dirt, dust and grease from exposed components.

7.5.9 A qualified technician can be found with an authorized distributor/dealer.

## 7.6 Transporting and Storing

7.6.1 The wheelchair may be disassembled for ease of transport. Please refer to Section 5 for more detailed information on the individual steps. Reverse the order for reassembly.

7.6.2 Remove the seat from the lower body. Be sure that the controller is detached from the seat.

7.6.3 Remove the swing-away footrests.

7.6.4 Carry the body of the wheelchair by the front and back frame using two people. Do not lift the lower body by the casing or any detachable parts

7.6.5 Please store the wheelchair in a location where it is out of direct sunlight, rain and dew.

7.6.6 When stored for a long time, please charge the batteries to full and then disconnect the battery terminals.



### WARNING

- As of this date, Saber GT series can NOT be used as seats in any vehicles. That is, KARMA recommends that users are NOT transported in any vehicle while seated in the wheelchair. In the case of accident or a sudden stop, the user or passengers may be at risk of getting injury. The suggested solution is to transfer the user from the wheelchair into a vehicle seat and to securely stow the wheelchair in a separate compartment.

## 7.7 KP-45.6T(R) Instructions for Lubrication

7.7.1 Right & Left Slide Rails (Fig.7.1)

7.7.2 Actuator Pintle (Fig.7.2)

7.7.3 The Pivot Points of Seat Links & Frame (Fig.7.3)

7.7.4 The Pivot Points of Seat Links & Seat Support Frame (Fig.7.4)

7.7.5 The Pivot Shafts of Seat Frame and Slide (Fig.7.5)

7.7.6 The Caster Fork Anti-Shock Screw (Fig.7.6)



(Figure 7.1)



(Figure 7.2)

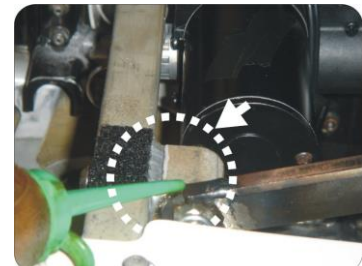

(Figure 7.3)

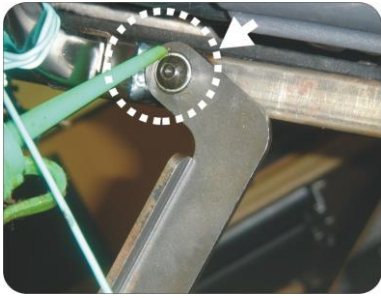

(Figure 7.4)



(Figure 7.5)



(Figure 7.6)







## CAUTION

- Before lubrication, do clean the area.
- When lubricating, use just 1-2 drops of oil (not grease), as extra oil will fall on the rug and pollution as a result of over-lubrication.
- Depending on how often you use the chair, normally 1-2 times of lubrication per month is fine. Proper lubrication can extend the life span of a part in addition to prevent noise from accruing. Check if the bolts are fastened while lubrication.

## 8. TROUBLESHOOTING

Trouble or Problems with Your Wheelchair

You can inspect the following before taking your wheelchair to a KARMA wheelchair dealer.











Problem	Checking Points and Corrective Action
My wheelchair does not start	Is the power turned OFF?  Turn ON the power.
	Do the batteries still have power? Is the battery indicator light not on?  Charge the batteries.
	Is the charger plugged into the wheelchair?  Unplug the charger and put it away.
	Is the seat release lever to be locked?  Unlocked the seat release lever.



If you cannot solve the problem by yourself, contact your KARMA wheelchair dealer for help.

## 8.1 VR2 Controller, Battery & Diagnostics Indicator

The following table indicates what the gauge will display for any given state.

### ■ VR2 Controller

Indication	Status	Meaning	What to do
	1 signal	The battery needs charging or there is a bad connection to the battery.	Check the connections to the battery. If the connections are good, try charging the battery.
	2 signals	The left hand motor has a bad connection.	Check the connections to the left hand motor.
	3 signals	The left hand motor has a short circuit to a battery connection.	Connect your service agent.
	4 signals	The right hand motor has a bad connection.	Check the connections to the left hand motor.
	5 signals	The left hand motor has a short circuit to a battery connection.	Connect your service agent.
	6 signals	The wheelchair is being prevented from driving by an external signal.	Please remove the charger.
	7 signals	A joystick fault is indicated.	Make sure that the joystick is in the center position.
	8 signals	A joystick fault is indicated.	Make sure that all connections are secure.
	9 signals	The parking brakes have a bad connection.	Check the parking brake and motor connections and make sure all connections are secure.
	10 signals	An excessive voltage has been applied to the control system.	Check the battery connections.

Indication	Status	Meaning	What to do
	7 signals + S	A communication fault is indicated.	Make sure that joystick cable is securely connected and not damaged
	8 signals + A	An Actuator trip is indicated	If more than one actuator is fitted check which actuator is not working correctly. Check the actuator wiring.

## 9. SPECIFICATIONS

Product Model	KP-45.6	KP-45.6T	KP-45.6TR
Nominal seat width (mm/in)*	460 / 18	510 / 20	510 / 20
Nominal seat depth (mm/in)**	425 / 16	490 / 20	490 / 20
Front caster / Drive wheel size (in)	9 / 16	9 / 16	9 / 16
Backrest height (mm)	535	550	550
Headrest height above seat (mm)	635 ~ 680	675 ~ 720	675 ~ 720
Armrest to seat distance (mm)	175 ~ 245	175 ~ 245	175 ~ 245
Front location of armrest structure (mm)	60 ~ 560	255 ~ 600	255 ~ 600
Seat surface height at front edge (mm)	580	600	600
Footrest to seat distance (mm)	410 ~ 455	410 ~ 455	410 ~ 455
Effective seat width (mm)	460 ~ 530	525 ~ 545	525 ~ 545
Effective seat depth (mm)	485	510	510
Seat plane angle (X°)	10	6 ~ 45	7 ~ 46
Backrest angle (X°)	0 ~ 67	5 ~ 26	7 ~ 36
Seat to backrest angle (X°)	0 ~ 147	88 ~ 110	90 ~ 119
Leg to seat angle (X°)	107 ~ 179	102 ~ 179	106 ~ 176
Overall length with legrest (mm)	1125 ~ 1595	1150 ~ 1470	1150 ~ 1600
Overall width (mm)	645 ~ 685	650 ~ 695	650 ~ 695
Overall height (mm)	865 ~ 1230	1000 ~ 1340	990 ~ 1360
Folded length (mm)	895	950	900
Folded width (mm)	650	650	650
Folded height (mm)	870	1090	1095
Total mass (kg)	104.2 (50Ah PbAc)	117.4 (50Ah PbAc)	133.9 (50Ah PbAc)
	127.6 (80Ah PbAc)	140.8 (50Ah PbAc)	157.3 (50Ah PbAc)
	88.6 (50Ah LFP)	101.8 (50Ah LFP)	118.3 (50Ah LFP)
Total mass without batteries (kg)	73.0	86.8	103.3
Mass of the heaviest part (kg)	70.0	80.0	96.0
Maximum user weight (kg)	135	135	135
Motor power (W)	320	320	320
Battery capacity (Ah)	50*2 (PbAc)	50*2 (PbAc)	50*2 (PbAc)

	80*2 (PbAc) 51.2*1 (LFP)	80*2 (PbAc) 51.2*1 (LFP)	80*2 (PbAc) 51.2*1 (LFP)
Charger output current (A)	6 (PbAc) / 10 (LFP)	6 (PbAc) / 10 (LFP)	6 (PbAc) / 10 (LFP)
Drive range (km)***	41.7 (50Ah PbAc) 64.0 (80Ah PbAc) 45.7 (50Ah LFP)	41.7 (50Ah PbAc) 64.0 (80Ah PbAc) 45.7 (50Ah LFP)	41.7 (50Ah PbAc) 64.0 (80Ah PbAc) 45.7 (50Ah LFP)
Battery Compartment (L x W x H) (mm)	340 x 200 x 160	340 x 200 x 160	340 x 200 x 160
Maximum speed forward (km)	13	13	13
Minimum braking distance from max speed (mm)	3100	3100	3100
Obstacle climbing (mm)	50	50	50
Ground clearance (mm)	55	55	55
Minimum turning radius (mm)	1035	1065	1050
Minimum turning radius without user (mm)	905	935	920
Reversing width (mm)	1300	1360	1340
Static stability downhill (X°)	16	16	16
Static stability uphill (X°)	19	19	19
Static stability sideways (X°)	15.5	15.5	15.5
Dynamic stability uphill (X°)	6	6	6
Ability to climb rated slope (X°)***	12	12	12

\* **Nominal seat width** is measured the width of seat cushion at 120mm in front of the backrest. This value is mainly used in the product ordering process.

\*\* **Nominal seat depth** is measured from the front end of the seat cushion to the back cushion. This value is mainly used in the product ordering process.

\*\*\* **Drive range/ Ability to climb rated slope** are estimated based on the following conditions: 20°C~35°C, 135 kg occupant, brand new fully charged batteries and driving on the flat road.

- The actual product specifications differ from the data in the table by  $\pm 1$  cm  $\pm 0.5$  kg.
- The actual product specifications may vary according to different configurations.
- Karma reserves the right to modify information herein without further notice.
- If you want to know more about the measurement methods of wheelchair specifications, please scan the QR code to watch the instructions on the Karma website.





## 10. CLEANING & RECYCLING

### 10.1 Cleaning

- 10.1.1 In order to lengthen the life of your wheelchair, it is suggested that you clean the wheelchair periodically (if not daily), especially after it is used in the rain or snow.
- 10.1.2 We suggest that you don't use your wheelchair in the rain or snow.
- 10.1.3 If you are traveling and get caught in the rain, we suggest you try to find shelter and turn OFF your wheelchair while waiting it out.
- 10.1.4 If you can't find any shelter, proceed to your destination.
- 10.1.5 However we do not recommend you do this often as it may shorten the life of your wheelchair or cause damage.
- 10.1.6 Driver's seat upholstery: use soapy water. Wring out the sponge/ cloth before scrubbing. Do not use the wheelchair until it is dry.
- 10.1.7 Frame: wipe it with a damp cloth, but be sure not to splash/spray the wheelchair with water, as doing so may damage the motor, electrical wiring and battery.
- 10.1.8 If compressed air is available, you can use the compressed air to clean your wheelchair (do not exceed 7K and keep the nozzle at least 10 cm away from your wheelchair).
- 10.1.9 Casing: wipe with a damp cloth. After it is dry, coat the casing with a light layer of wax, if desired.

### 10.2 Post-Consumer Recycling

- 10.2.1 A post-consumer recycling plan should follow the Environmental Protection Administration's regulations.
- 10.2.2 The items listed below are for reference only as local law and regulation may vary.

Material	Part Name	Method
Aluminum-alloy	Frame	Recyclable
ABS	Various	Recyclable
Various	Battery	Recyclable
Various	Motor/Reduction Gear	Recyclable
Various	Electric Parts	Recyclable

10.2.3 There are many organizations in many countries you can find on the internet that will accept used goods for charity or disassemble electronic equipment and batteries to recycle them.

10.2.4 Please search the information highway to help less fortunate individuals and protect our planet for future generations.

10.2.5 If you do not have access to the world wide web please use your local phone directory, ask for operator assistance or go to your local government center for more information.

10.2.6 Various parts of this wheelchair should be recycled to the collection and recycling location nearest to you. Earth Day is every day.

Check with your local recycling center on where and how to recycle used batteries as this information varies from region to region.



# 11. WARRANTY

## 11.1 Serial Number

To ensure after-sale service and warranty, please record and fill in the serial number. The serial number can be found on the steering column below the control panel.

This warranty is VOID if the original chair serial number is removed or altered.

Model	Saber GT Series
Serial Number	

## 11.2 Contents and Duration of Warranty

- 11.2.1 If the parts of the product need to be repaired or replaced due to manufacturing defects, they can be repaired or replaced free of charge within the warranty period (a repair of this kind will hereafter be called warranty maintenance).
- 11.2.2 Frame is warranted for a period of 5 years and electrical system (controller, motor, charger, actuator and PCB) for a period of 1 year after delivery to the customer, then the affected parts will be repaired or replaced free of charge.
- 11.2.3 Battery warranty is subject to the periods set by the manufacturers. Please contact your local dealer in detail.
- 11.2.4 Consumable parts such as bearings, cables, carbon brushes, circuit breakers, covers, footplates, light bulbs, pads, side guards, upholsteries, wheels and similar parts are excluded from the warranty.
- 11.2.5 Warranty maintenance can be performed by authorized KARMA wheelchair dealers only.
- 11.2.6 KARMA is not responsible for the transportation costs for repair and replacement.
- 11.2.7 Warranty maintenance is the repair or replacement according to the condition of the parts, and replaced parts will be the property of KARMA.
- 11.2.8 KARMA reserves the right to modify product specifications without further notice; KARMA is not responsible for any changes to product specifications.

## 11.3 The Claims from This Warranty Shall Not Arise for The Following Reasons

- 11.3.1 The product or part has been damaged by accident, improper use, incorrect assembly or poor maintenance. The evaluation of it is the privilege of

KARMA.

11.3.2 Damage resulting from normal wear and tear.

11.3.3 Any overloading of the product, please check the label for maximum user weight.

11.3.4 The product or part has not been maintained or serviced in accordance with the manufacturer's recommendations as shown in the User Manuals and/or the Service Manuals.

11.3.5 Use or install parts or accessories which are not manufactured or not approved by KARMA.

11.3.6 Damage resulting from use in unsuitable environments.

11.3.7 Damage resulting from any addition, modification, or alteration of the product or parts without the approval by KARMA.

11.3.8 Damage resulting from external factors, such as chemicals, oil, debris, etc.

11.3.9 Damage caused by natural disasters.

## **11.4 The Responsibilities of the User**

11.4.1 Fully adhere to operation guidelines set forth in this manual.

11.4.2 Perform self-inspection and basic maintenance.

11.4.3 Keep a record of self-inspections and basic maintenance.

11.4.4 Not permit any alteration, addition, or modification or use of parts not manufactured by KARMA.

11.4.5 Thoroughly read and understand this manual.

## **11.5 The Responsibilities of the Dealer**

11.5.1 Follow this owner's manual and educate user about product operation and basic maintenance

11.5.2 Verify and check whether the warranty conditions are met.

11.5.3 Provide relevant warranty information and recommendations for improvements.



### **CAUTION**

- **Do not drive a wheelchair that is older than 10 years without having its structure inspected.**

## 11.6 Transfer of Warranty Rights

If you purchase a second-hand KARMA wheelchair while it is still within the warranty period, bring this user manual and the wheelchair to the authorized dealer and perform necessary product inspection, maintenance and warranty inheritance procedure.

Full Name:	
Gender:	<input type="checkbox"/> Male <input type="checkbox"/> Female
Date of Birth:	Year                      Month                      Day
Address:	
Model:	KARMA Saber GT Series
Serial Number:	
Date of Purchase:	Year                      Month                      Day
Purchaser Signature:	

### Dealer's Data

Name of the Store:	
Phone No. and Address:	

If you have any suggestions on how to improve our products, please don't hesitate contacting your local dealer to let us know what you think of your wheelchair.  
Thank you and enjoy.





# karma

A Better Wheelchair, A Better Fit



KARMA MOBILITY S.L European Support Center.  
[www.karmamobility.es](http://www.karmamobility.es)  
+34 984 390 907  
[karma@karmamobility.es](mailto:karma@karmamobility.es)

KARMA MEDICAL PRODUCTS CO., LTD.  
[www.KarmaMedical.com](http://www.KarmaMedical.com)  
+886 5 206 6688  
[globalsales@karma.com.tw](mailto:globalsales@karma.com.tw)