

karma

A Better Wheelchair, A Better Fit

Powered Wheelchair Owner's Manual

KP12 Series



■ KP-12



■ KP-12T

CE

GENERAL WARNING

IMPORTANT

Do not attempt to use the wheelchair before a qualified person has explained to your satisfaction how to operate it without risk to yourself or others.



WARNING:

DO NOT OPERATE THIS EQUIPMENT WITHOUT FIRST READING AND UNDERSTANDING THIS MANUAL. IF YOU ARE UNABLE TO UNDERSTAND THE WARNINGS, CAUTIONS AND INSTRUCTIONS, CONTACT A DEALER, HEALTHCARE PROFESSIONAL OR TECHNICAL PERSONNEL IF APPLICABLE BEFORE USE THIS EQUIPMENT--OTHERWISE, INJURY OR ATTEMPTING TO DAMAGE MAY RESULT. PROCEDURES OTHER THAN THOSE DESCRIBED IN THIS MANUAL MUST BE PERFORMED BY A QUALIFIED TECHNICIAN.

THE INFORMATION CONTAINED IN THIS DOCUMENT IS SUBJECT TO CHANGE WITHOUT NOTICE.



WARNING:

As a manufacturer of power wheelchairs, KARMA endeavors to supply a wide variety of power wheelchairs to meet the many needs of the user. However, the responsibility of final selection of the type of power wheelchair to be used by an individual rests solely with the user and his/her health care professional capable of making such a selection. KARMA recommends that power wheelchair users NOT be transported in vehicles of any kind while in a power wheelchair. As of this date, the Department of Transportation (U.S.) has not approved any tie-down systems for transportation of a user while on a power wheelchair in a moving vehicle of any type. It is the position of Karma that users of power wheelchairs should be transferred into appropriate seating in vehicles for transportation and make use of the restraints made available by the auto industry. Karma cannot and does not recommend any power wheelchair transportation systems.

It is the responsibility of the Durable Medical Equipment (DME) Dealer, therapists and other healthcare professionals to determine if a seat positioning strap is required to ensure the safe operation of this equipment by the user. Serious injury can occur in the event of a fall from a power wheelchair.

Operating Information

Adjustments should ONLY be made by professionals of the healthcare field or persons fully conversant with this process and the driver's capabilities. Incorrect settings could cause injury to the driver or bystanders and damage to the power wheelchair and surrounding property.

To determine and establish your particular safety limits, practice bending, reaching, mounting and dismounting activities in several combinations in the presence of a qualified healthcare professional BEFORE attempting active use of the power wheelchair.

- ⊙ For individuals with balance problems, practice mounting and dismounting activities WITH AN ASSISTANT in the presence of a qualified healthcare professional.
- ⊙ If so equipped, DO NOT operate the wheelchair without anti-tippers being installed. Anti-tippers MUST BE attached at all times.
- ⊙ DO NOT attempt to reach objects if you have to move forward in the seat or pick them up from the floor by reaching down between your knees as this may cause loss of balance.
- ⊙ DO NOT lean over the back of the chair to reach objects behind you as this may cause the power wheelchair to tip over.
- ⊙ DO NOT shift your weight or sitting position toward the direction you are reaching as the power wheelchair may tip over.
- ⊙ DO NOT use an escalator to move a power wheelchair between floors. Serious bodily injury may occur.
- ⊙ DO NOT operate in car lanes on roads, streets, highways, etc.
- ⊙ DO NOT attempt to move up or down an incline with a water, ice or oil film.
- ⊙ DO NOT attempt to ride over curbs or obstacles. Doing so may cause your power wheelchair to turn over and cause bodily harm and/or damage to the power wheelchair.
- ⊙ DO NOT make sharp turns, in forward or reverse, at excessive speeds.
- ⊙ DO NOT attempt to lift the power wheelchair by its casings and seat.
- ⊙ DO NOT attempt to lift the power wheelchair by any detachable parts. Lifting by means of any detachable parts of a power wheelchair may result in injury to the user or damage to the power wheelchair. Please hold onto the frame when lifting your wheelchair.
- ⊙ DO NOT operate the power wheelchair until you have checked that the surroundings are clear and that the area is safe for travel.
- ⊙ DO NOT use tilt-in-space function on a slope. (KP-12T)
- ⊙ Please pay attention to the environment, and to keep away from the hazard of external flame. When the user is smoking, pay attention to safety and make sure to extinguish the fire when finished. Be alert to the environment when someone nearby is smoking or using a cigarette lighter, keep away from the hazard and use fire-proof cloth.
- ⊙ DO NOT use parts, accessories or adapters other than those authorized by Karma. Before attempting to sit in or exit the power wheelchair, turn the power OFF. This will ensure that the power wheelchair will not drive. Turn the power OFF while the wheelchair is not in use. Otherwise, injury and/or damage to the wheelchair and surrounding property may occur.
- ⊙ DO NOT connect any medical device (i.e., a ventilator, life support machine, et cetera) to the battery. This could cause unexpected failure of the device and the power wheelchair. KARMA specifically disclaims responsibility to all personal injury and property damage that may occur during use which does not comply with applicable federal, state and local laws and ordinances.
- ⊙ DO NOT stand on the footplates of the power wheelchair.

- ⊙ DO NOT be towed by other vehicles (cars, motorcycles or bicycles, etc.) Only use freewheel mode on flat surfaces since your electromagnetic brakes are not engaged in this mode, without these brakes it will roll down a hill causing injury or damage. Never drive under the influence of alcohol or medication.
- ⊙ DO NOT sit in the powered wheelchair within a moving vehicle unless it has been affixed the labels of hook mark.

RAMPS

DO NOT climb, go up or down ramps or traverse slopes greater than the safe climbing angle for your model specified in section 10. When negotiating ramps, if the joystick is released while moving forward, the power wheelchair will roll backwards approximately one foot before the brake engages. If the joystick is released while in reverse, the power wheelchair will roll backwards approximately two and a half feet before the brake engages.

Be sure to reduce your speed when driving on curved roads or making a turn; do not drive at full speed. Please drive at a slower speed so you have complete control of the wheelchair.

ELECTRICAL

Check to ensure that all electrical connections are secure at all times. Grounding Instructions: DO NOT, under any circumstances, cut or remove the round grounding prong from any plug. Some devices are equipped with three-prong (grounding) plugs for protection against possible shock hazards. Where a two-prong wall receptacle is encountered, it is the personal responsibility and obligation of the customer to contact a qualified electrician and have the two-prong receptacle replaced with a properly grounded three-prong wall receptacle/outlet in accordance with the National Electrical Code and local laws. Do not use a n extension cord when charging your batteries. A risk of fire and /or electric shock could be encountered.

BATTERIES

The warranty and performance specifications contained in this manual are based on the use of deep cycle sealed lead acid batteries. KARMA strongly recommends their use as the power source for this unit. (Refer to chapter 6) Carefully read the battery and charger information prior to installing, servicing or operating your wheelchair.

RAIN

DO NOT leave your power wheelchair in a rain of any kind.

DO NOT use your power wheelchair in a shower or leave it in a damp bathroom while taking a shower.

DO NOT leave your power wheelchair in a damp area for any length of time. Direct exposure to rain or dampness could cause the power wheelchair to malfunction electrically and mechanically and may cause the power wheelchair to prematurely rust.

WEIGHT LIMITATION

The maximum weight that can be carried, including goods, is stated beside "Max. User Weight" in section 10. SPECIFICATIONS.



Figure 1

STAIRWAYS

DO NOT attempt to move an occupied power wheelchair between floors using a stairway. (See Figure 1)

Use an elevator to move an occupied power wheelchair between floors. If moving a power wheelchair between floors by means of a stairway, the occupant **MUST** be removed and transported independently of the power wheelchair. Extreme caution is advised when it is necessary to move an **UNOCCUPIED** power wheelchair up or down stairs. Karma recommends disassembling the wheelchair and transporting the components independently up or down stairs. Make sure to use **ONLY** secure, non-detachable parts on each component for hand-held supports.

DO NOT attempt to lift a power wheelchair by any removable (detachable) parts. Lifting by means of removable (detachable) parts may result in injury to the user or assistants or damage to the wheelchair.

ESCALATORS? SORRY!

DO NOT use an escalator to move a power wheelchair between floors. Serious bodily injury and damage to the wheelchair may occur.

YOU AND YOUR KARMA SERVICE PROVIDER

No tools are required for assembly. Your wheelchair should be assembled by your authorized Karma dealer. Your authorized Karma dealer is also your service provider. Unauthorized repairs, upgrades, and add-ons will negate your warranty. Anything wheelchair-related that requires tools should be performed by your authorized Karma service provider. Your Karma service provider has the necessary service manual for your wheelchair.

If you have any defective parts or lose any parts, please contact your dealer for repair and/or replacement. Please only use parts authorized by Karma. Use of parts that are not authorized by Karma will negate your warranty.

Part numbers are listed on our bill of materials (explosion drawings), which we give to our authorized dealers and service providers. Customers should order parts through their dealer as well as all repairs and scheduled maintenance.

Customers should go to their dealership for all service needs to guarantee their warranty is not nullified. Always go to an authorized service provider. Unauthorized repairs will nullify your warranty. Procedures other than those described in this manual must be performed by a qualified technician.

They also have the service manual with a complete list of maintenance required to keep your Karma wheelchair in top performance. Check the warranty section of this manual to find out what Karma guarantees and what maintenance and parts you will have to pay for.

Karma does not have an official list of service providers at this time. Please contact your dealer for service. If you cannot contact your dealer, please contact another authorized Karma dealer for service. If all else fails, contact Karma directly via our website or give us a call and we can refer you to your new service provider.

CLASSIFICATION & INTENDED USE

Karma's KP-12 and KP-12T are classified as a class B mobility product for indoor and outdoor use. This wheelchair is suitable for users up to 60 kg in weight. It also has an extremely durable aluminum alloy frame with tough accessory and does not suffer in dramatic extremes of temperature (neither user nor attendant need touch metal parts in normal use).

Check with your local government as to legislation pertaining to mobility vehicles to assure your legal requirements to drive on public roads have been met, i.e. a safety belt, lighting, registration or licensing.

CE MARKING

This power wheelchair complies with the requirements of the Medical Devices Directive 93/42/EEC.

TABLE OF CONTENTS

1. PREFACE	1
2. SAFETY	1
2.1 BEFORE DRIVING	1
2.2 WHILE DRIVING	2
2.3 KP-12 AND KP-12T LABELING	4
3. EMI/RFI	6
4. KP-12T PARTS	8
5. OPERATION	10
5.1 VR II JOYSTICK CONTROLLER	10
5.2 HOW TO OPERATE YOUR WHEELCHAIR	10
5.3 FREEWHEEL LEVERS	12
5.4 ADJUSTMENT	13
5.5 KP-12, KP-12T DISASSEMBLY AND ASSEMBLY	17
5.6 TRANSFERRING IN AND OUT	19
6. BATTERIES AND CHARGER	19
6.1 CHARGING THE BATTERIES	19
6.2 CHARGER	21
6.3 BATTERIES	21
7. INSPECTION AND MAINTENANCE	22
7.1 DAILY CHECK	22
7.2 REGULAR MAINTENANCE RECORD	23
7.3 TIRES	24
7.4 GENERAL MAINTENANCE	24
7.5 TRANSPORTING AND STORING	25
8. TROUBLESHOOTING	25
9. SPECIFICATIONS	27
10. CLEANING & RECYCLING	27
11. WARRANTY	28
11.1 SERIAL NUMBER	28
11.2 WARRANTY POLICY	29



1. PREFACE

Please carefully read this owner's manual before using the wheelchair. Improper use of the wheelchair could result in harm, injury or traffic accidents. Therefore, for safe and enjoyable use of the wheelchair, please read this owner's manual.

This owner's manual includes operation instructions for the aspects of the wheelchair, assembly instructions, and instructions on how to deal with possible accidents.

This owner's manual is written for Karma power wheelchair(s): KP-12 and KP-12T.

The symbols used in this manual are explained below. Pay special attention to the parts marked with these symbols.

 WARNING:	Improper use could lead to serious injury or death.
 CAUTION:	Improper use could lead to injury and/or damage to your wheelchair.
 SUGGESTION:	Follow these instructions to keep the wheelchair in good condition.

This manual includes the repair and maintenance chart as well as the Warranty. Please keep it in a safe place or with the wheelchair. If someone else uses the wheelchair, make sure that you give him or her this owner's manual for his or her reference.

As designs change, some illustrations and pictures in this manual may not correspond to the vehicle that you purchased. We reserve the right to make design modifications without further notice.

2. SAFETY

2.1 Before Driving

The user must be familiar with the use and operation of this wheelchair before driving. Therefore, please always keep these safety guidelines in mind.

Traffic Rules

Pedestrian traffic rules apply to this wheelchair. Please be safe. Drive only on pedestrian areas such as the sidewalk. Never drive the wheelchair on the highway.

Be aware of other vehicles when crossing all roads.

Be extremely cautious when driving your wheelchair in heavy traffic or the shopping mall.

DO NOT drive your wheelchair when you feel tired or consume alcohol.

Please do not drive your wheelchair at night.

Please follow pedestrian traffic lights.

Practice Driving

Before you are familiar with the operation of your wheelchair please practice in a wide and open area, like a park. To avoid falling off your wheelchair please practice all kinds of driving motions, such as accelerating, stopping, turning, reversing and going up and down ramps. Please set the speed to medium when you first start practicing. Be safe. Make sure someone accompanies you in case you need assistance.

Be sure you are able to control and operate your wheelchair easily and confidently before you move the speed higher.

No Passengers

KARMA wheelchairs are limited to one driver. Do not carry passengers (including children) on your wheelchair.

No Hauling Heavy Goods

Do not use this wheelchair to carry or haul heavy goods.

The maximum weight that can be carried, including goods, is stated beside "Max. User Weight" in section 10. SPECIFICATIONS.

RAIN

This product is not guaranteed to be water resistant. Please do not drive in the rain, through puddles or spray water to clean this product.



Figure 2.1

2.2 While Driving

Please carry out daily inspections. Refer to section 7.1 DAILY CHECK

General Warning

Do not lean over the side of the wheelchair as such an action may cause you to lose balance and fall. Use caution to assure your clothing doesn't get tangled with the wheels.

Railroad Crossing

Before crossing the tracks, please stop completely and look both ways. Cross the tracks perpendicular to avoid your wheels getting stuck.

Do not drive at full speed over railroad tracks.

Circumstances to Avoid

Avoid roads with heavy traffic, mud, excessive gravel or bumps, snow and ice. These conditions may damage your wheelchair. Avoid roads that are too narrow or by a canal/waterway without any fence/hedge. Also avoid places where your wheels might get stuck, slip or not have traction. Do not drive in a gale, at night or in rainy/snowy/foggy/misty weather. These conditions may cause your wheelchair to rust. (See Figure 2.2)

Do not drive in a S curve, do doughnuts or make sudden turns.

Do not take an escalator.

Mobile Phones and Other Electric Equipment

Do not use a mobile phone or other wireless communication devices while driving. (See Section 3. EMI/RFI)

Do not charge the mobile phone or other electric devices from your wheelchair's batteries.

Ramps, Inclines and Drops

Do not drive onto a steep ramp. Refer to "Safe Climbing Slope " in section 10-SPECIFICATIONS for your wheelchair's safe climbing angle.

When climbing up to an inclined road, please set the speed higher than the medium speed and drive carefully. (See Figure 2.3) When going down an inclined road, set the speed to "1" and never use reverse.

Do not drive on a road with many bumps and holes close to each other, such as potholes or washboard roads. (See Figure 2.4)

Do not make sudden turns when driving on gravel roads or ramps.

The maximum surmountable obstacle height is 5cm for your wheelchair. Exceeding this obstacle height will damage your wheelchair and negate your warranty. (See Figure 2.5)

When negotiating an obstacle slow down, put your seat into the full upright position and approach it head on (perpendicular). Just before the obstacle, speed up until the entire wheelchair has conquered the obstacle. Negotiating an obstacle at an angle may cause your wheelchair to tip over. Don't do it!

When climbing down a curb, slow down just before you get to it and only speed up after the entire wheelchair has lowered to the road. Again, descending obstacles should be done perpendicularly. (See Figure 2.6)

Karma does not design wheelchairs to take jumps over or off obstacles. Doing so will negate your warranty.

WARNING:

Do not set the wheelchair in freewheel mode when on an incline or decline.

If you breakdown on railroad tracks, first, check for an oncoming train. If a train is coming, get out of its way immediately! If no train is coming, set to freewheel mode and push the wheelchair off the tracks.

Maximum User Weight Limit

Refer to "Max. User Weight" in section 10. SPECIFICATIONS. Loads exceeding maximum capacity can damage your wheelchair and cause malfunctions yielding a safety hazard. The warranty does not cover damage caused by improper operation of the wheelchair.



Figure 2.2



Figure 2.3



Figure 2.4



Figure 2.5



Figure 2.6

2.3 KP-12 and KP-12T Labeling

Please carefully read all the labeling on the wheelchair before driving it. Do not remove them. Protect them for future reference.

Karma Medical Products Co., Ltd.		
2363, Sec. 2 University Rd., Min-Hsiung, Chia-Yi 621, Taiwan		
TYPE	KP-12T	
V max.	6 km/h	max. 8°
KG	60 kg	SN: <input type="text"/>

EC	REP	Karma Medical European representative:
		KARMA MOBILITY, S.L.
C/ PERIODISTA FRANCISCO CARANTOÑA DUBERT, 23 Bajo 33209 GIJÓN - ASTURIAS (SPAIN)		
Tel: (+34) 984 390 907 E-mail: karma@karmamobility.es		



RIGHT **LEFT**



Be careful when folding!

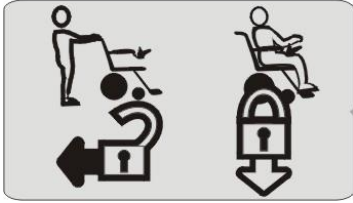

Circuit Breaker
Press To Reset

⚠
If there are any problems or unusual situations with the battery or power system, please contact your KARMA wheelchair dealer for help.
NEVER disassemble or repair the battery, otherwise, injury or damage may occur. This will negate the warranty.

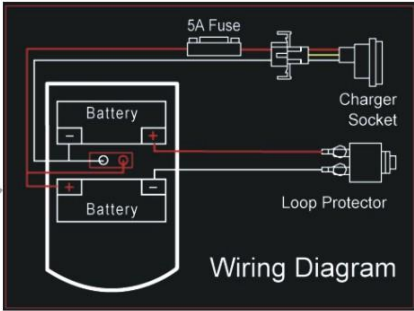

Battery pack

(inside)

3. EMI/RFI

This section provides the user with basic information about the problems with EMI, known sources of EMI and protective measures either to reduce the possibility of exposure or to minimize the degree of exposure. This section also shows some conditions in which unexpected or erratic wheelchair movements may occur.

CAUTION:

It is very important that you read this information regarding the possible effects of electromagnetic interference on your electric KARMA wheelchair.

Electromagnetic Interference From Radio Wave Sources

Powered vehicles may be susceptible to electromagnetic interference (EMI), which is interfering electromagnetic energy (EM) emitted from sources such as radio stations (Radio Frequency Interference), TV stations, amateur radio (HAM) transmitters, two-way radios, and cellular phones. The interference (from radio wave sources) can cause the powered vehicle to release its brakes, move by itself, or move in unintended directions. It can also permanently damage the powered vehicle's control system. The intensity of the interfering EM energy can be measured in volts per meter (V/m). Each powered vehicle can resist EMI up to a level of intensity. This amount of resistance is called its immunity level. The higher the immunity level is, the greater the protection will be. At this time, current technology is capable of achieving at least a 20 V/m immunity level, which would provide useful protection from the more common sources of radiated EMI. This powered vehicle model, with no further modification, has an immunity level of 20 V/m without any accessories.

There are a number of sources of relatively intense electromagnetic fields in our everyday environment. Some of these sources are obvious and easy to avoid. Others are not apparent and exposure could be unavoidable. However, we believe that by following the warnings listed below, your risk to EMI can be greatly minimized.

The sources of radiated EMI can be broadly classified into three types:

1. Hand-held portable transceivers (transmitter-receivers) with the antenna mounted directly on the transmitting unit, such as citizens band (CB) radios, walkie-talkies, security and fire or police transceivers, cellular telephones and other personal communication devices;

NOTE:

Some cellular telephones or similar devices transmit signals while they are ON, even though they are not in use.

2. Medium-range mobile transceivers used in police cars, fire trucks, ambulances and taxis usually having the antenna mounted on the outside of the vehicle; and
3. Long-range transmitters and transceivers, such as commercial broadcast transmitters (radio and TV broadcast antenna towers) and amateur (HAM) radios.

NOTE:

Other types of hand-held devices (cordless phones, laptop computers, AM/FM radios, TV sets, CD players, cassette players, and small appliances such as electric shavers and hair dryers, et cetera) so far as we know, are not likely to cause EMI problems.

Powered Vehicle Electromagnetic Interference (EMI)

Because EM energy rapidly becomes more intense as one moves closer to the transmitting antenna (source), the EM fields from hand-held radio wave sources (transceivers) are of special concern. It is possible to unintentionally bring high levels of EM energy too close to the powered vehicle's control system while using these devices. This can affect your powered vehicle's movement and braking. Therefore, the warnings listed below are recommended to prevent possible interference with the control system of the powered vehicle.

Warnings

Electromagnetic interference (EMI) from sources such as radio and TV stations, amateur radio (HAM) transmitters, two-way radios and cellular phones can affect powered vehicles and motorized wheelchairs. Following the warnings listed below should reduce the chance of unintended brake release or powered vehicle movement that could result in serious injury.

1. Do not operate hand-held transceivers-receivers such as citizens band (CB) radios or turn ON personal communication devices such as cellular phones, while the powered vehicle is turned ON.
2. Be aware of nearby transmitters, such as radio or TV stations, and try to stay away from them.
3. If unintended movement or brake release occurs, turn the powered vehicle OFF as soon as it is safe.

**CAUTION:**

Some stores may have automatic (sensor) doors and alarm systems set at certain frequencies that might affect your power wheelchair.

4. Be aware that adding accessories/components or modifying the powered vehicle may make it more susceptible to EMI. There is no easy way to evaluate their effect on the overall immunity of the powered vehicle.
5. Report all incidents of unintended movement or brake release to your powered vehicle dealer or KARMA, and note whether there was a source of EMI nearby.

Important Information

1. 20 Volts per meter (V/m) is a generally achievable and useful immunity level against EMI (the higher the level is, the greater the protection will be.)
2. This product has an immunity level of 20 V/m without any accessories connected to it.

4. KP-12T PARTS

Parts Description



- | | |
|---------------------------------------|--|
| 1. Head Support | 9. Motor |
| 2. Back Support Angle Adjustment Base | 10. Castor (Caster) |
| 3. Back Support | 11. Foot Support |
| 4. Lateral Trunk Support | 12. Posterior Foot Support |
| 5. Arm Support | 13. Medial Upper Leg Support (Thigh Separator) |
| 6. Anterior Pelvic Support | 14. Seat |
| 7. Lateral Upper Leg Support | 15. Controller Mounting Tube |
| 8. Drive Wheel | 16. Controller |

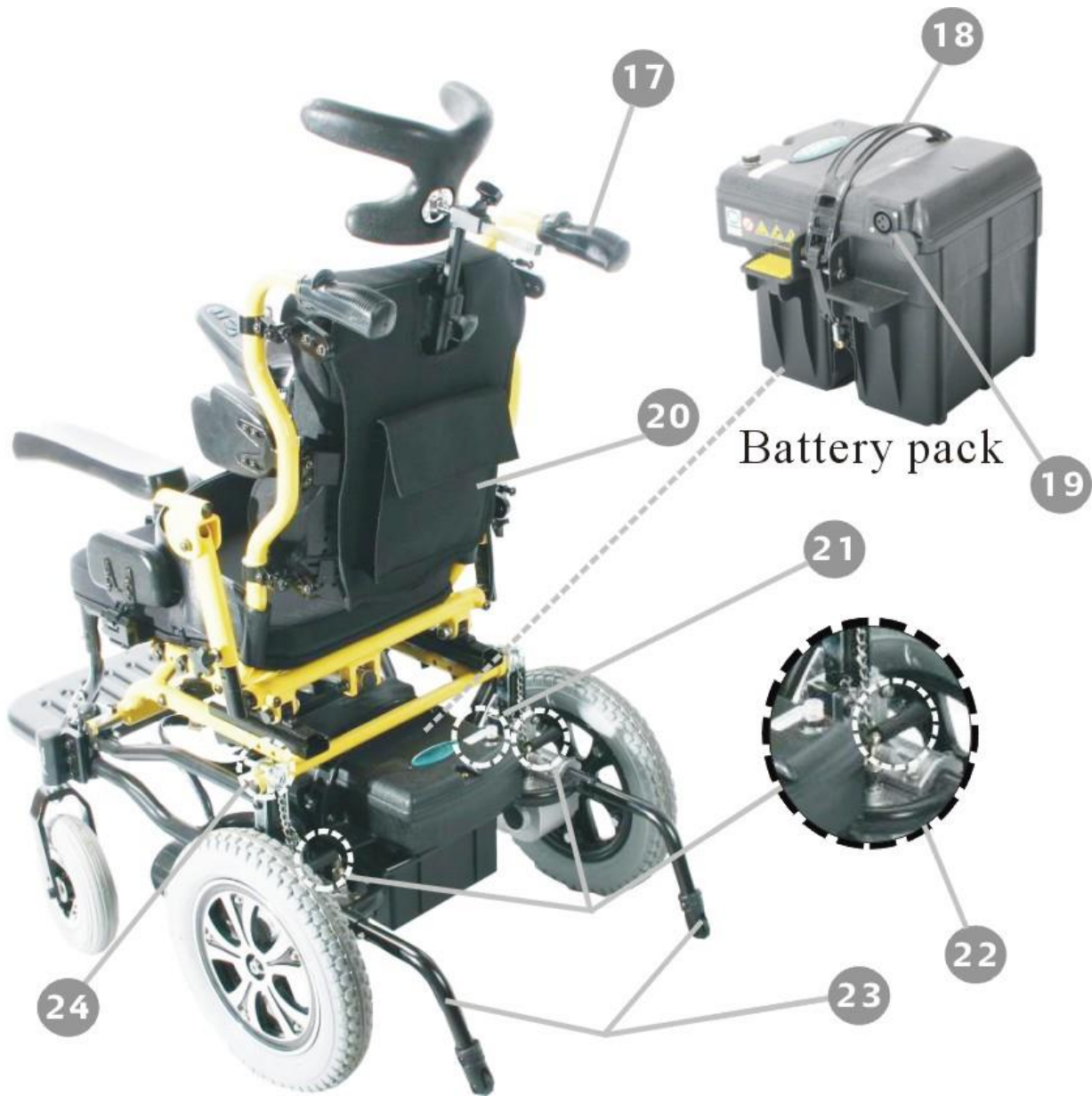

- 17. Handgrip
- 18. Battery Handle
- 19. Charging Socket
- 20. Backpack

- 21. Fuse
- 22. Freewheel Lever
- 23. Anti-tipper
- 24. Lock Pin

5. OPERATION

5.1 VR II Joystick Controller

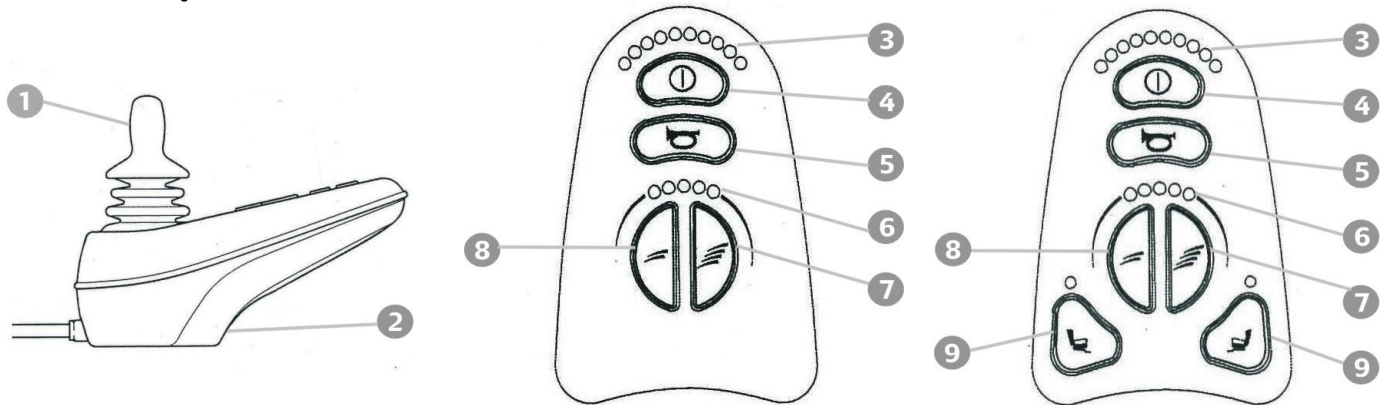

- | | |
|------------------------------------|-----------------------------|
| 1. Joystick | 6. Speed Indicator |
| 2. Charger Socket | 7. Speed Increase Button |
| 3. Battery & Diagnostics Indicator | 8. Speed Decrease Button |
| 4. ON/OFF Button | 9. Actuator Button (KP-12T) |
| 5. Horn Button | |

5.2 How to Operate Your wheelchair

5.2.1 Power ON/OFF

Press the power button. Be sure not to touch the joystick while turning on the controller. Your battery & diagnostics indicator should light up.

5.2.2 Speed Adjustment Buttons

The speed increase/decrease button allows you set various forward and reverse speeds. The settings are a percentage of maximum power. Notice the orange dots on the speed indicator. The more orange dots, the faster your speed.

CAUTION:

- ⊙ Please slow down before you get used to control your power wheelchair.
- ⊙ Please slow down your speed when indoors.

5.2.3 Driving Speed

You can choose between 1 to 5 orange dots in the speed indicator, with 5 being the maximum speed. Please refer to "Max. Speed" in section 10. SPECIFICATIONS.

Speed Scale	Speed Equivalencies and Recommended Circumstances
1-2	Speed equivalent to walking slowly on foot On an decline Driving indoors or in a narrow space
3-4	Equivalent to walking at a normal speed

	Driving outdoors on flat ground
5	Speed equivalent to a brisk walk Driving in an open space On an incline

5.2.4 Forward, Reverse and Braking

Push forward on the joystick to make the wheelchair move forward.

Pull back on the joystick for the wheelchair to move backward.

Release the joystick and the wheelchair will quickly slow down, the electromagnetic brake will be activated to stop the wheelchair.

Come to a complete stop before turning the power OFF.



CAUTION:

1. The stopping distance will vary with your forward/reverse speed. Therefore, please gradually slow down and come to a complete stop well before any obstacles or danger.
2. To park the wheelchair, be sure to park on flat ground and then turn the power to OFF.
3. NEVER use the freewheel mode when going down an incline. The electromagnetic brake won't function in freewheel mode.

5.2.5 Horn Button

The horn will sound for the duration of time the button is pressed.

5.2.6 Battery Indicator

When the power is turned on, the battery indicator will light up with a possible total of three red, four orange and three green dots indicating the remaining power of the batteries. All of the green lights being lit indicate that the batteries are fully charged. If only the red dots are lit, this indicates that the batteries are out of (or nearly out of) power.

SUGGESTION:

1. It is recommended that you charge the batteries immediately when the battery indicator shows only three or less red dots.
2. After charging or replacing new batteries, drive the wheelchair for 2-3 minutes to make sure the batteries are fully charged before going on a long journey.
3. In wintertime, the batteries may respond slowly and the drive range may also be reduced. You must store your wheelchair indoors above freezing temperatures.
4. When driving on an incline, the battery indicator light might move up and down. This is normal.
5. Even if the batteries are used properly their capacity will decay over time, thereby reducing the drive range (maximum distance traveled per full charge). Thus, when the drive range becomes about 50% of what brand new batteries would offer, it's time to replace them with new batteries. Otherwise, the batteries may die unexpectedly leaving you in a possibly precarious situation.
6. The drive range will be shortened when driving frequently on slopes or uneven ground, as this consumes more battery power.

5.2.7 Tilt Operation (KP-12T)

1. Turn the power on.
2. Press the actuator button. (See 5.1 VR II Joystick Controller)
3. Moving the joystick backward will tilt the seat in that direction. The maximum tilt angle can reach to 30°
4. Moving the joystick forward will tilt the seat in that direction.

Pressing the actuator button again puts controller back in drive mode.

CAUTION:

The power wheelchair cannot be driven while the seat is in tilt condition. (The speed indicator will flash in this condition.)

Do not tilt the seat on a slope.

5.3 Freewheel Levers

The KP-12 and KP-12T are supplied with freewheel levers to allow for manual pushing of the power wheelchair if required.

To select neutral from the engaged position:

Rotate the two levers located on the top of both motors, 90 degrees outward. The wheelchair will now roll freely. (See Figure 5.3.1.)

To engage the motors from the neutral position:

Simply rotate the levers 90 degrees inward toward the attendant. (See Figure 5.3.2.)

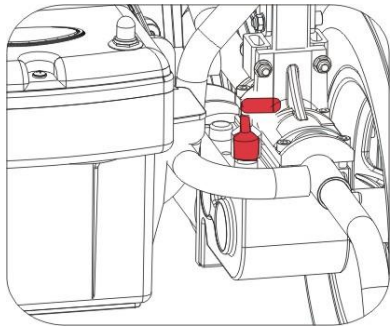

Figure 5.3.1

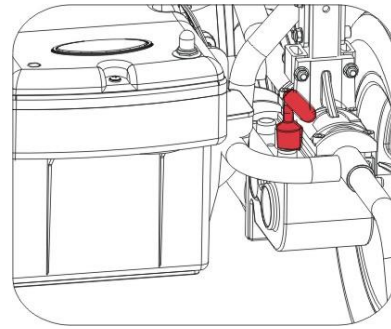

Figure 5.3.2

⚠ CAUTION:

Always ensure that the freewheel levers are engaged before you turn on the controller.

5.4 Adjustment

5.4.1 Seat Depth Adjustment

Seat depth can be adjusted at two positions that are of 2.2 cm difference.

1. Flip up arm support.
2. Pull up seat to remove. (See Fig 5.4.1.)
3. Pull out the lock pin. (See Fig 5.4.2.)
4. Pull up and move backward to remove back support. (See Fig.5.4.3.)

Unscrew the 4 pieces of screws on both side of seat frame and adjust the seat depth to the desired position, and then retighten the screws by using tools supplied by KARMA. (Adjust both sides simultaneously. See Fig.5.4.4.)



Figure .5.4.1



Figure .5.4.2

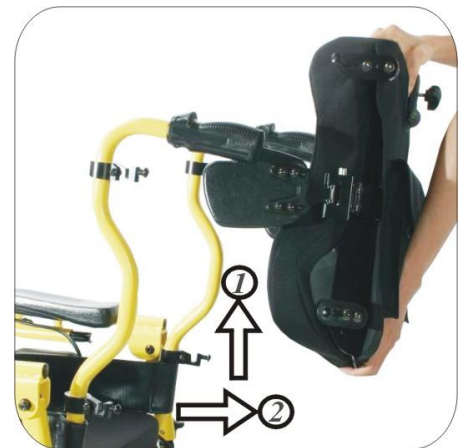

Figure .5.4.3

5.4.2 Swing-away and Restoration of Lateral Trunk Support

Swing-away: Press and hold the head of pivot and then swing lateral trunk support outward. (See Fig.5.4.5.)

Restoration: Press and hold the head of pivot and then swing lateral trunk support inward.

5.4.3 Swing-away of Lateral Upper Leg Support

Press and hold the head of pivot and then swing lateral upper leg support downward. (See Fig.5.4.6.)

Restoration: Press and hold the head of pivot and then flip-up lateral upper leg support.



Figure.5.4.4



Figure.5.4.5



Figure.5.4.6

5.4.4 Adjustment for Lateral Upper Leg Support

There is 3.5 cm being adjustable at one side. And there are 7 segments being adjustable in fore and aft and each segment is of 3 cm..

1. Pull up and remove the seat. (See Fig 5.4.1.)
2. Unscrew the screws on the seat back and adjust width fore and aft according to the occupant's need, and then tighten the screws. (See Fig 5.4.7.)

5.4.5 Adjustment for Medial Upper Leg Support (Thigh Separator)

Loose the knob bolt under the seat and adjust fore and aft according to the occupant's need and then retighten the knob bolt. (See Fig 5.4.8.)

5.4.6 Adjustment for Lateral Trunk Support

1. Remove the cover of the back support. (See Fig 5.4.9.)
2. Loose the screws on the back support plate and adjust the width and height according to the occupant's need and then retighten the screws. (See Fig 5.4.10.)
3. Put the cover of back support to its original position

5.4.7 Adjustment for Back Support Angle

The angle adjustment range of back support is 15 degrees measured from the vertical line without tilt.

1. Pull out the lock pin. (See Fig 5.4.2.)
2. Pull up and move backward to remove the back support. (See Fig.5.4.3.)
3. Unscrew the 8 screws at the upper and lower parts on both sides of the back support to adjust the back support angle according to the occupant's need and then retighten the screws. (See Fig.5.4.11.)

Caution: This adjustment can only be performed by an authorized technician. If you do the adjustment by yourself, it might possibly cause damage to the wheelchair or result in the occupant's injury.

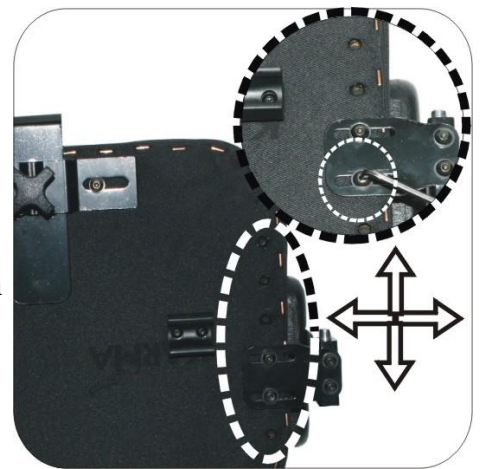

Figure.5.4.7



Figure.5.4.8



Figure.5.4.9

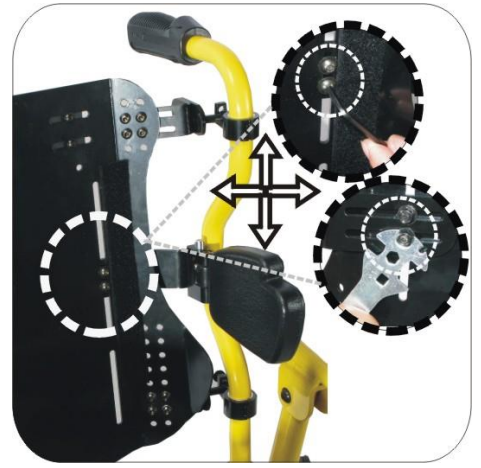

Figure.5.4.10

5.4.8 Height Adjustment for Back Support

1. Remove the cover of the back support. (See Fig.5.4.9.)
2. Unscrew the 8 screws at the upper and lower parts on both side of back side of back support and according to the occupant's desire adjust the back support height and then retighten the screws (See Fig.5.4.12.) You can also unscrew the hanging bracket of back support and adjust the back support height, and then retighten the screws. (See Fig.5.4.13.) Do not lose the liner, otherwise the hanging bracket of back support cannot be retighten.



Figure.5.4.11

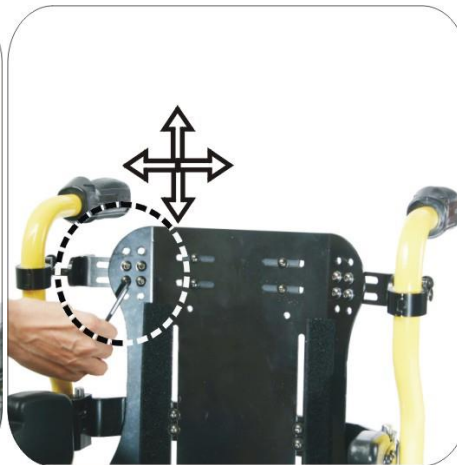

Figure.5.4.12

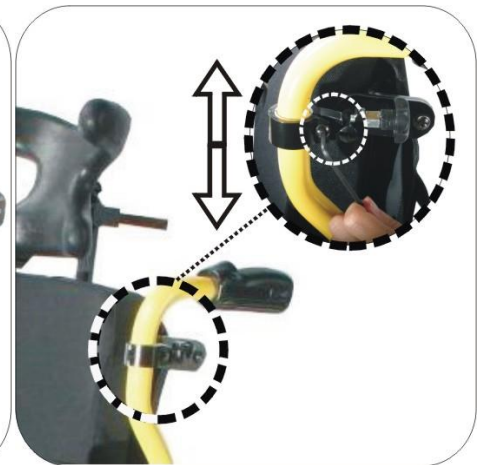

Figure5.4.13

5.4.9 Adjustment for Back Support Hanger and Hanging Bracket

If the hanger cannot be inserted to hanging bracket, or that the back support interfere with the seat resulting from the adjustment of back support and seat, you can adjust hanger as shown in Fig.5.4.12, and hanging bracket as shown in Fig.5.4.13.

Do make both fit each other and then retighten the screws. (Do not lose the liner, otherwise the hanging bracket of back support cannot be retighten.)

5.4.10 Adjustment for Head Support

Height Adjustment: Unscrew the knob bolts and adjust the head support height and then retighten the knob bolt. (See Fig.5.4.14)

Fore and Aft Adjustment: Unscrew the knob bolts and adjust the head support fore and aft and then retighten the screw. (See Fig.5.4.15)

Right-left Adjustment:

1. Remove the cover of back support. (See Fig.5.4.9)
2. Unscrew the screws on the up of back of back support and adjust the head support to right or left and then retighten the screws (See Fig.5.4.16)



Figure.4.14



Figure.5.4.15

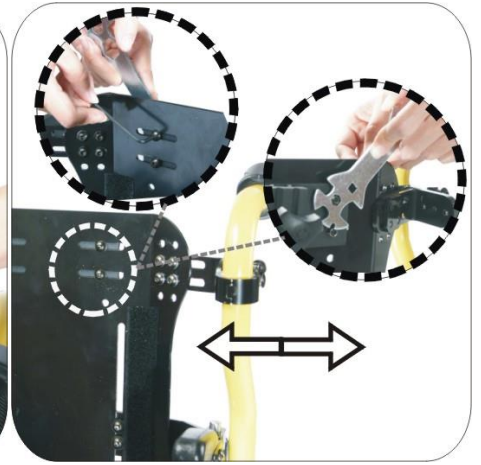

Figure.5.4.16

5.4.11 Flip-up the Arm Support

Directly rotate the arm support upward. (See Fig.5.4.17)

5.4.12 Arm Support Height Adjustment

Height can be adjusted 5 positions with 1.5cm increment.

Unscrew the knob bolt and according to the occupant's desire to adjust the height and then align the hole to retighten the knob bolt. (See Fig.5.4.18)

5.4.13 Arm Support Width Adjustment

There are 4 positions with 1.5 cm increment can be adjusted in one side.

Unscrew the screw behind the seat frame and according to the occupant's desire to adjust arm support width and then align the to retighten the screw. (See Fig.5.4.19)



Figure.5.4.17

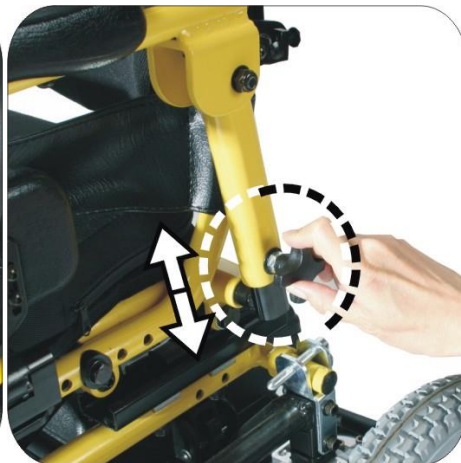

Figure.5.4.18



Figure.5.4.19

5.4.14 Adjustment for Controller Position

Fore and aft adjustment: Loose the knob bolt to adjust the controller fore and aft position. (See Fig.5.4.20.)

Height adjustment:

1. Press and hold the release button and pull out to remove the controller. (See Fig.5.4.21.)
2. Loosen the screws on the controller fixing tube to adjust the height and then retighten the screws. (See Fig.5.4.22.)
3. Press and hold the release button to put the controller to its original position.



Figure.5.4.20



Figure.5.4.21



Figure.5.4.22

5.4.15 Foot Support Fore and Aft Adjustment

There are 3 positions with 2 cm increment for fore and aft adjustment. Unscrew the screw on the seat frame and according to the occupant's desire to adjust the foot support fore and aft and then align the hole to retighten. (See Fig.5.4.23)

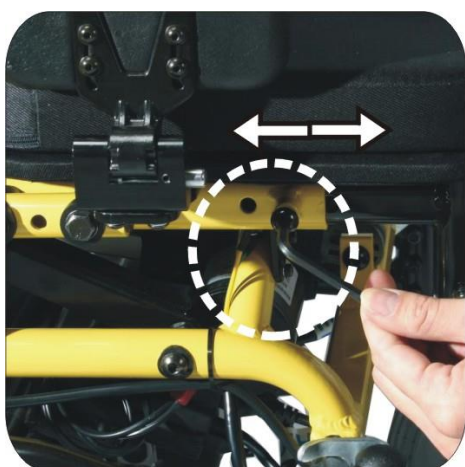

Figure.5.4.23



Figure.5.4.24

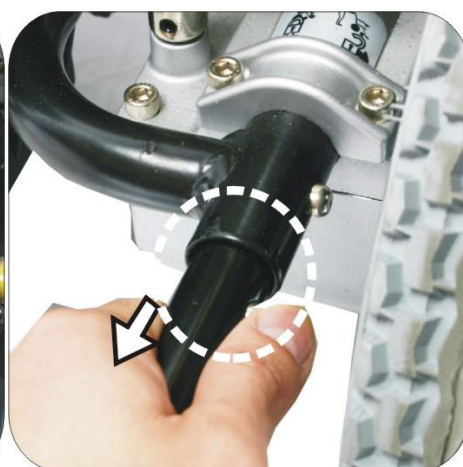

Figure.5.4.25

5.4.16 Foot Support Height Adjustment

There are 3 positions with 2.2 cm increment for height adjustment. Unscrew the screw on the adjustable foot support frame and adjust the foot support height and then align the hole to retighten. (See Fig.5.4.24)

5.4.17 Attaching the Anti-tipper

Pressing the rear button let the release button go into the inside of tube and then insert the anti-tipper into the frame rear tube and release the button to lock. (Make sure that the release button goes into the hole. See Fig.5.4.25.)

5.5 KP-12, KP-12T Disassembly and Assembly

KP-12/KP-12T can be disassembled to include seat assembly, chassis and battery box which is convenient for storage and transportation.



1. Press the gray button on the No.1 plug and pull it out to remove the cable from the power module. (For KP-12 and KP-12T.) Pull out the No.2 and No.3 plugs to remove the cables from the power module. (For KP-12T only.) (Plug No.2 connects the black and red wires. Plug No.1 connects the yellow and green wires.)

2. Flip-up the foot support.



3. Pull out the lock pin on both rear side of seat frame.



4. Pull the seat upward backward to remove it.



5. Hold onto the battery handle and lift it up.

Assemble KP-12, KP-12T by reversing this procedure.

⚠ CAUTION:

1. Turn off the power and engage the parking brake before you disassemble and assemble KP-12, KP-12T.
2. The heaviest component is chassis, which weights 24 kg.
3. Please be careful about hands' injury when assemble and disassemble.
4. Always use the anti-tippers on your wheelchair to prevent injury.
5. Please put the arrow on the top of the battery case to forward.

5.6 Transferring In and Out

5.6.1 Transferring In

1. Turn off the power and engage the parking brake.
2. Flip-up the foot support.
3. Lower the occupant into the seat, and use the arm support for support.
4. Restore the foot support.

5.6.2 Transferring Out

1. Make sure that the chair is near your final destination.
2. Turn off the power and engage the parking brake.
3. Flip-up the foot support or/and arm support.
4. Move your body to the destination.

CAUTION:

Never stand on the foot support when getting in or out of the chair.

6. BATTERIES AND CHARGER

CAUTION:

Before you attempt charging, ensure you read and understand the instruction manual supplied with the battery charger, and you choose the correct input voltage for battery charger.

6.1 Charging the Batteries

Charge your batteries if any of the following conditions occur.

1. If you have used your wheelchair for more than an hour continuously;
2. You've used more than one third of the total charge;
3. When you haven't used the wheelchair for more than two weeks;
4. If the current charge is not enough to reach your final destination

Be sure to follow the procedures precisely listed below.

1. Turn the wheelchair OFF.
2. Connect the charger's cord to a power outlet.
3. There are two charging sockets: one is at the front of controller and another is at the battery pack. (See figure 6.1 and 6.2.) Then connect the charger's plug to the charging socket.
4. The charger's orange LED will light up as soon as the charging starts. The charging time is at least 6 hours, but it could be as long as 10 hours, depending on the status of the batteries and temperature.
5. The orange LED will change to green when the charging is completed
6. Disconnect the cord and pull out the round plug from the charging socket.

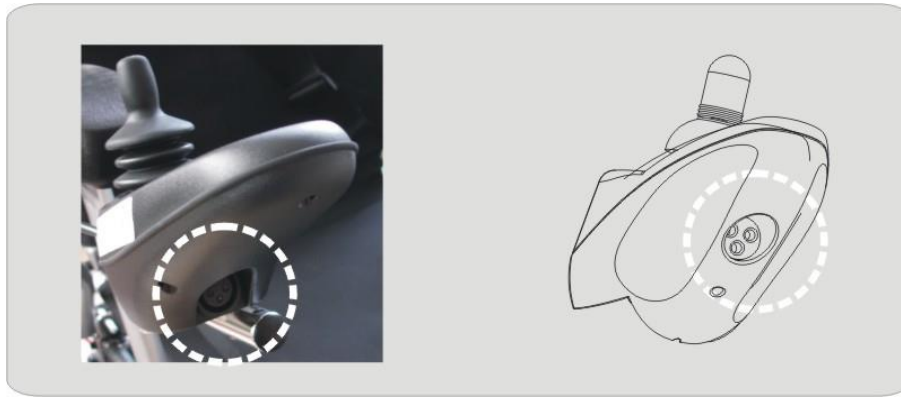

(Figure 6.1)



(Figure 6.2)

i SUGGESTION:

1. Do not disconnect the charger cord if the charging is not completed. The battery life will be seriously shortened or decayed if the batteries are repeatedly used without being fully charged. Therefore, be sure to always charge the batteries fully.
2. Always complete the charging by letting the charge LED light turn green. NEVER stop charging before it is complete.
3. When finished charging, disconnect the charger plug from the charging socket as soon as possible. Even when the charger is turned OFF, the electric power will slowly discharge if the cord is not disconnected. DO NOT leave the charger ON connected to the wheelchair for more than 24 hours.
4. Charging time depends on the surrounding temperature; it takes longer in the winter.

⚠ CAUTION:

Please follow the guidelines below to avoid accidents while charging.

1. Be sure to only use a KARMA approved battery charger and charge the battery completely every time. The battery can be damaged if a non-genuine charger is used.
2. Never disassemble or modify the charger. This will negate the warranty.
3. Please charge in a well-ventilated area where the battery is not directly exposed to sunlight. Do not charge the battery under rainfall, in morning dew or in an area where the humidity is high.
4. Do not cover the wheelchair with any waterproof cloth or other objects while charging. Don't charge in temperatures less than -10 C (14 F) or higher than 50 C (122 F) as the charger may not work well and the battery may become damaged.
5. The charger is not guaranteed to be water resistant.
6. Valve Regulated Lead-Acid batteries do not have a memory function like cell phone batteries have. Please get in the habit of recharging your VRLA batteries frequently.

 **WARNING:**

1. Keep your wheelchair away from flammable objects while charging, as it may lead to fire or explosion of the battery.
2. Since the battery may produce hydrogen, do not smoke while charging and charge in a well-ventilated area.
3. Never connect or disconnect the plug (cord) with wet hands or if the plug (cord) is wet to avoid possible electric shock.
4. Never attempt to recharge the batteries by attaching cables directly to the battery terminals or clamps. **DO NOT** jump start your wheelchair!
5. Do **NOT** attempt to recharge the batteries while the power wheelchair is in operation.

 **CAUTION:**

1. New batteries **MUST** be fully charged prior to initial use of the power wheelchair.
2. Always charge new batteries before initial use or battery life will be reduced.
3. As a general rule, recharge batteries as frequently as possible to assure the longest possible life and to minimize required charging time. Plan to recharge them when use of the power wheelchair is not anticipated.

6.2 Charger

The battery charger supplied by Karma is for indoor use only, and it must be protected from moisture and external heat source.

 **CAUTION :**

Before charging, make sure to set the 115V ↔ 230V switch to match the local AC voltage. If the switch is improperly set to a lower or higher voltage position, it will cause damage to the charger, and battery. Change the 115V ↔ 230V switch settings only when charger is disconnected from AC line voltage.

 **WARNING:**

The fan inside the charger will start to work when you turn on the charger. (8A, will start to work as temperature is over 50°C and stop running under 50°C) If you find that the fan does not function properly, **DO NOT** use the charger. Otherwise, the charger may overheat and start a fire.

6.3 Batteries

Do not expose the batteries to temperatures below -10 C (14 F) or above 50 C (122 F) when charging or storing the vehicle. Exceeding the specified temperature range can lead to either freezing or overheating of the batteries. This will damage the batteries and shorten their lives.

The batteries used on your wheelchair are maintenance free sealed lead acid batteries. Thus, it is not necessary to change or refill the battery liquid.

 **WARNING:**

1. Do not open the battery seal cap at any time.
2. After ANY adjustments, repair or service and BEFORE use, make sure that all hardware is tightened securely. Otherwise, injury or damage may occur.
3. When removing/installing batteries, keep all foreign objects, especially metal, away from battery terminals.

 **CAUTION:**

Place the power wheelchair in a well-ventilated area where work can be performed without risking damage to carpeting or floor covering.

 **CAUTION:**

Failure to use the correct battery size and/or voltage may cause damage to the power wheelchair and give unsatisfactory performance.

 **WARNING:**

There are many risks involved with improper disposal of batteries, whether damaged or not. Batteries may contain heavy metals and be considered hazardous waste.

Many regions around the world now strictly enforce laws to help protect our environment. By not disposing of batteries properly, you may be liable for fines from your local through national government.

By not recycling batteries, they end up in landfills that are already low on space. From these landfills, lead and other chemicals may leach into streams and rivers destroying ecosystems and poisoning local water resources.

Improper disposal of batteries may also cause injury to unsuspecting others that come in contact with them. If you come in contact with fluids or corroded powder from a battery, rinse with water and contact a physician if necessary. If contact with eyes occurs, rinse for 15 minutes and then visit a physician.

Incinerating or burning a battery will cause it to explode! Please see the end of section 11. Cleaning & Recycling for more information.

Do not use an extension cord when charging your batteries.
A risk of fire and /or electric shock could be encountered.

7. INSPECTION AND MAINTENANCE

7.1 Daily Check

Check the following items before driving. If you find anything abnormal, visit your KARMA wheelchair dealer for further inspection before using it.

Item	Inspection Content
Joystick Controller	Is the joystick loose and/or making noise? Can the joystick be turned left and right smoothly? Can the speed buttons be adjusted freely and do they function well? Does the wheelchair stop when the joystick is released completely? Does it light up when the power is ON? Is there enough power for your trip? Does the horn work well?
Motor	Is there any abnormal motor noise? Does the electromagnetic brake work properly?
Freewheel Mode	Do the freewheel levers work properly?
Driver's Seat	Does the driver's seat recline? Do the seat angle adjustment knobs(or buttons)work properly? Does the surface of the seat remain or break?
Tires	Are there any cracks or other damage to the tires? Check the tire tread depth and air pressure.
Other	Is there any abnormal noise?

 **CAUTION:**

Visit a KARMA wheelchair dealer for inspection and maintenance if you find anything abnormal.

7.2 Regular Maintenance Record

To make sure your wheelchair is in good condition, visit your KARMA wheelchair dealer regularly for maintenance (and keep records accordingly) every six months after purchasing. A maintenance/service fee may apply.

 **SUGGESTION:**

Even if you don't use the wheelchair for a long time, the wheelchair should still be maintained regularly. You should clean your wheelchair, inside and out, regularly to keep it beautiful and safe.

- I - Inspection A - Adjustment △ - Repair
3 - Replacement T - Tightening L - Add Oil

Item/Period (in Months)	1	6	12	18	24	30
Joystick Control Unit		I	I	I	I/3	I/3
Power Module		I	I	I	I/3	I/3

Controller Buttons			I	I	I	I/3	I/3
Connection to the Electrical System				I		I	I/A
Motor	Operation and Noise		I	I	I/A	I/A	I/3
	Electromagnetic Brakes		I	I	I	I/3	I/3
	Connection to the Electrical System			I		I	
Batteries	Loose or Corroded Terminals			I		I	
	Connection to the Electrical System			I		I	
	Damage to the Electrical Cord/Cable			I		I	
Charger	Charging Function and LED Lights	I	I	I	I/△	I/△	I/△
	Socket, Plug and Cords			I		I	
	Fan Functions Properly			I		I/△	
Driver's Seat	Recline Levers			I/L		I/L	
Tires	Cracks/Surface Damage	I/3	I/3	I/3	I/3	I/3	I/3
	Tread Depth		I	I/3	I	I/3	I
	Abnormal Wear Pattern			I/3		I/3	
Wheel Rim	Tightness of Bolts and Nuts			T		T	
	Wear or Deformation Around Tires			I/3		I/3	

7.3 Tires

The condition of the tires is affected by the way you drive and use your wheelchair.

Inspecting Tire Tread: please check the tread depth regularly.

Replace the tires when the tread depth is less than 0.5mm.

7.4 General Maintenance

You must maintain the vehicle more frequently if you drive on grass, sand or gravel roads often.

Do not use water, oil or other chemical solutions to clean your wheelchair. Be sure NOT to spray the vehicle with water, as not to damage the electronic components and PCB circuit board. Please clean the vehicle by wiping it with either a dry or moist cloth. Please take the vehicle to an authorized KARMA wheelchair dealer for repairs and adjustments. Improper adjustments could lead to wheelchair malfunction or an accident.

 CAUTION:

Before performing any maintenance, be sure to turn the power OFF and unplug the charger if connected.
DO NOT over-tighten hardware. This could cause damage to the frame and hardware.

i SUGGESTION:
Do not directly spray water on your wheelchair to wash it, as this could lead to a malfunction in the electric system.
Do not use gasoline, solvents or other abrasive solutions; the casing may become deformed or damaged.

⊘ WARNING:
After ANY adjustments, repair or service and BEFORE use, make sure that all hardware is tightened securely, otherwise injury or damage may occur.

Suggested Maintenance Procedures before you use the power wheelchair: make sure all nuts and bolts are tight. Check all parts for damage or wear and have a qualified technician replace it if necessary. Check all parts for proper adjustment.
Ensure that the batteries are properly maintained and charged as required. Inspect brake for proper operation. The wheels and tires should be checked periodically for cracks and wear, and should be replaced by a qualified technician.
Regularly check for loose nuts and/or bolts in the front and rear wheels. If loose, have them adjusted by a qualified technician. Clean dirt, dust and grease from exposed components. A qualified technician can be found with an authorized distributor/dealer.

7.5 Transporting and Storing

The wheelchair may be disassembled for ease of transport. Please refer to section 5 for more detailed information on the individual steps. Reverse the order for reassembly.
Please store the wheelchair in a location where it is out of direct sunlight, rain and dew. When stored for a long time, please charge the batteries to full and then disconnect the battery terminals. For more details, consult your KARMA wheelchair dealer.

8. TROUBLESHOOTING
Trouble or Problems with Your Wheelchair

You can inspect the following before taking your wheelchair to a KARMA wheelchair dealer.











Problem	Checking Points and Corrective Action
My wheelchair does not start	Is the power turned OFF? Turn ON the power.

	Do the batteries still have power? Is the battery indicator light not on? Charge the batteries.
	Is the charger plugged into the wheelchair? Unplug the charger and put it away.

If you cannot solve the problem by yourself, contact your KARMA wheelchair dealer for help.

VRII Controller, Battery & Diagnostics Indicator

The following table indicates what the gauge will display for any given state.

Indication	Status	Meaning	What to do
	1 signal	The battery needs charging or there is a bad connection to the battery.	Check the connections to the battery. If the connections are good, try charging the battery.
	2 signals	The left hand motor has a bad connection.	Check the connections to the left hand motor.
	3 signals	The left hand motor has a short circuit to a battery connection.	Connect your service agent .
	4 signals	The right hand motor has a bad connection.	Check the connections to the left hand motor.
	5 signals	The left hand motor has a short circuit to a battery connection.	Connect your service agent.
	6 signals	The wheelchair is being prevented from driving by an external signal.	Please remove the charger.
	7 signals	A joystick fault is indicated.	Make sure that the joystick is in the center position.
	8 signals	A joystick fault is indicated.	Make sure that all connections are secure.
	9 signals	The parking brakes have a bad connection.	Check the parking brake and motor connections and make sure all connections are secure.
	10 signals	An excessive voltage has been applied to the control system.	Check the battery connections.
	10 signals +	A communication fault is indicated.	Make sure that the joystick cable is securely connected

	Speed indicator		and not damaged.
--	-----------------	--	------------------

9. SPECIFICATIONS

Model	KP-12	KP-12T
Description		
Seat Width	12.5"~15"	
Frame	Aluminum-alloy	
Batteries	Sealed lead acid batteries	22Ah x2pcs
Max. Speed	6km/hr	
Motor	200W x 2pcs	
Range* (km)	13~16km	
Max. Safe Slope	8 degrees	
Brake System	Automatic Electromagnetic Brake	
Controller	PG Drives VR2	
Charger	Output 24V 4A	
Wheel Size	Casters: 200x 50 mm Rear Wheels: 12.5"x2.25"	
Tire Pressure	See the wall of tyre	
Turn Around Width	83cm	
Tilt in space	No	30°
Suspension System	No	
Overall Length	100cm(with Anti-tippers)	
Overall Width	62cm	
Overall Height	111cm (with head support)	
Turning Radius	83cm	
Weight W/O Batteries	40kg	42kg
Total Weight	56kg	58kg
Max. User Weight	60kg	

(±1cm ±0.5kg)

*Range (the maximum driving distance per complete charge) is estimated based on the following conditions: 20° C (68° F); an 60kg (176lbs) driver; brand new, fully charged batteries, and a constant driving speed of 6km/hr.

There are KP-12 and KP-12T two modes in KP-12 series. The only difference is the KP-12T with tilt in space.

10. CLEANING & RECYCLING

CLEANING

In order to lengthen the life of your wheelchair, it is suggested that you clean the wheelchair

periodically (if not daily), especially after it is used in the rain or snow. We suggest that you don't use your wheelchair in the rain or snow. If you are traveling and get caught in the rain, we suggest you try to find shelter and turn OFF your wheelchair while waiting it out. If you can't find shelter, proceed to your destination. However we do not recommend you do this often as it may shorten the life of your wheelchair or cause damage.

Driver's seat upholstery: use soapy water. Wring out the sponge/cloth before scrubbing. Do not use the wheelchair until it is dry.

Frame: wipe with a damp cloth, but be sure not to splash/spray the wheelchair with water, as doing so may damage the motor, electrical wiring and battery. If compressed air is available, you can use the compressed air to clean your wheelchair (do not exceed 7K and keep the nozzle at least 10cm away from your wheelchair).

Casing: wipe with a damp cloth. After it is dry, coat the casing with a light layer of wax, if desired.

POST-CONSUMER RECYCLING

A post-consumer recycling plan should follow the Environmental Protection Administration's regulations. The items listed below are for reference only as local law and regulation may vary.

Material	Part Name	Method
Aluminum-alloy	Frame	Recyclable
ABS	Various	Recyclable
Various	Battery	Recyclable
Various	Motor/Reduction Gear	Recyclable
Various	Electric Parts	Recyclable

There are many organizations in many countries you can find on the internet that will accept used goods for charity or disassemble electronic equipment and batteries to recycle them. Please search the information highway to help less fortunate individuals and protect our planet for future generations. If you do not have access to the world wide web please use your local phone directory, ask for operator assistance or go to your local government center for more information. Various parts of this wheelchair should be recycled to the collection and recycling location nearest to you. Earth Day is every day.

Check with your local recycling center on where and how to recycle used batteries as this information varies from region to region.



11. WARRANTY

11.1 Serial Number

To ensure after-sale service and warranty, please record and fill in the vehicle identification number. The serial number can be found on the steering column below the control panel.

Model	KP-12 / KP-12T
-------	----------------

11.2 Warranty Policy

11.2.1 Contents and Duration of Warranty

Contents of Warranty

1. Repair will be provided free of charge if the problems are due to manufacturing or defective components within the warranty period (a repair of this kind will hereafter be called warranty repair).
2. The warranty-covered repair can be performed by authorized KARMA wheelchair dealers only.
3. KARMA is not responsible for the transportation costs for repair and replacement.
4. Replaced parts will be the property of KARMA.

Warranty Duration and Parts Covered by the Warranty

Please contact your local dealer.

11.2.2 Items Not Covered by the Warranty

Items Not Covered

The items listed below are not covered:

1. Consumable parts such as brake shoes or pads, clutch shoe and lining, light bulbs, fuses, upholstery and seating, brake cable, oil seal packing and gasket, screws/bolts and washers, lubricant oil and grease, carbon brush inside the motor, battery liquid, footrest carpet, et cetera;
2. Those that do not affect the quality and functioning of the wheelchair such as noise or vibration;
3. Wear and tear resulting from usage as well as conditions resulting from lapse of time (e.g., normal aging and deterioration of paint, electroplating, plastic parts, etc);
4. Damage due to a lack of maintenance or improper operation and storage;
5. Fees for routine inspections, adjustments, adding oil, cleaning and other maintenance;
6. Fees for regular inspections and maintenance; and
7. Any fees incurred as a result of warranty repair, loss or compensation because of the unavailability of the wheelchair (telephone use, shipping, car rental, travel costs, et cetera).

Problems Not Covered

Problems caused by the following reasons are not covered:

1. Failure to carry out the regular inspection and maintenance recommended by this owner's manual;
2. Improper storage;
3. Tampering by changing or adding components to the vehicle, which are not approved by KARMA;
4. Damage caused by using non-KARMA genuine parts or other parts not recommended by KARMA;
5. Abuse or misuse of the vehicle such as driving over curbs and overloading the wheelchair

- with passengers or goods;
- 6. Driving in places where the vehicle should not normally be driven or used;
- 7. Damage or surface corrosion from environmental factors such as airborne fallout (chemicals, tree sap, et cetera), stones, hail, windstorms, lightning, floods and so on;
- 8. Change of any material or component parts not authorized by KARMA (Don't carry objects that may lead to the wheelchair being unbalanced);
- 9. The wheelchair shall not be pulled or pushed by another vehicle when there is a person on the wheelchair or the rear wheels are not set to the freewheel mode; and
- 10. Do not drive a wheelchair that is older than 10 years without having its structure inspected.

11.2.3 The Responsibilities of the User

The following items are the responsibility of the user:

- 1. Proper use of the vehicle in accordance with this Owner's Manual;
- 2. Performance of the daily inspections;
- 3. Performance of the regular maintenance recommended by KARMA; and
- 4. Keep a record of vehicle inspection and maintenance in the back of this Owner's Manual.

11.2.4 Warranty Effectiveness

The warranty form must be completely filled out and stamped by the KARMA dealership where the wheelchair was purchased.

11.2.5 Transfer of Warranty Rights

If you purchase a second-hand KARMA wheelchair while it is still with in the warranty period, bring the Owner's Manual and the vehicle to the dealership where the wheelchair was purchased for registration.

Warranty Form (You may photocopy this from)

Full Name:			
Gender:	Male <input type="checkbox"/>	Female <input type="checkbox"/>	
Date of Birth:	Year	Month	Day
Address:			
Model:	KP-12 , KP-12T		
Serial Number:			
Date of Purchase:	Year	Month	Day
Purchaser Signature:			

Dealer's Data

Name of Store:	
Telephone and Address:	

If you have any suggestions on how to improve our products, please don't hesitate contacting your local dealer to let us know what you think of your wheelchair. Thank you and enjoy.

Karma



Karma website



instagram

National agent:

Sold and serviced by:

KARMA MEDICAL PRODUCTS CO., LTD.

[Http://www.KarmaMedical.com](http://www.KarmaMedical.com)

E-mail:globalsales@karma.com.tw

KARMA reserves the right to modify information herein without further notice.